

A	B	C	D	A	B	C	D		
1	S359-0026	833	242	4/5	11	S359-5015	999	80	3/5
2	S359-0027	1461	415	4/5	12	S359-5016	999	80	3/5
3	S359-0028	1461	415	4/5	13	S359-5028	1712	80	3/5
4	S359-1034	1872	595	1/5	14	S359-5029	1712	80	3/5
5	S359-1035	1872	595	1/5	15	S359-9010	810	505	2/5
6	S359-1036	300	575	2/5	16	S359-9307	1869	977	1/5
7	S359-1037	300	575	2/5	17	ZQ2-1516	800	147	2/5
8	S359-2013	1020	628	2/5	18	ZQ3-521	350	120	2/5
9	S359-3016	966	595	2/5	19	ZQ3-522	350	120	2/5
10	S359-3017	966	575	2/5	20	dr-960	960	30	2/5

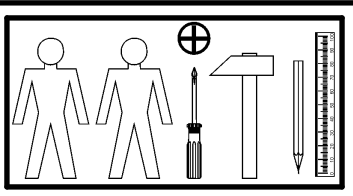

6x  a132	2x  a133	6x  b43	4x  c415	2x  d20	12x  d37	6x  e1	12x  e2	8x  e3
2x  e50	12x  e58	24x  f1	2x  f9	4x  f25	4x  j30	4x  k125	10x  l1	14x  l2
2x  n158	2x  p1	1x  p25	1x  p35	57x  p38	12x  p51	16x  r1	4x  r15	4x  r37
20x  r42	4x  r50	1x  t34	1x  w128/L	1x  w128/P	1x  n26/1	6x  s68	1x  z1	

1 

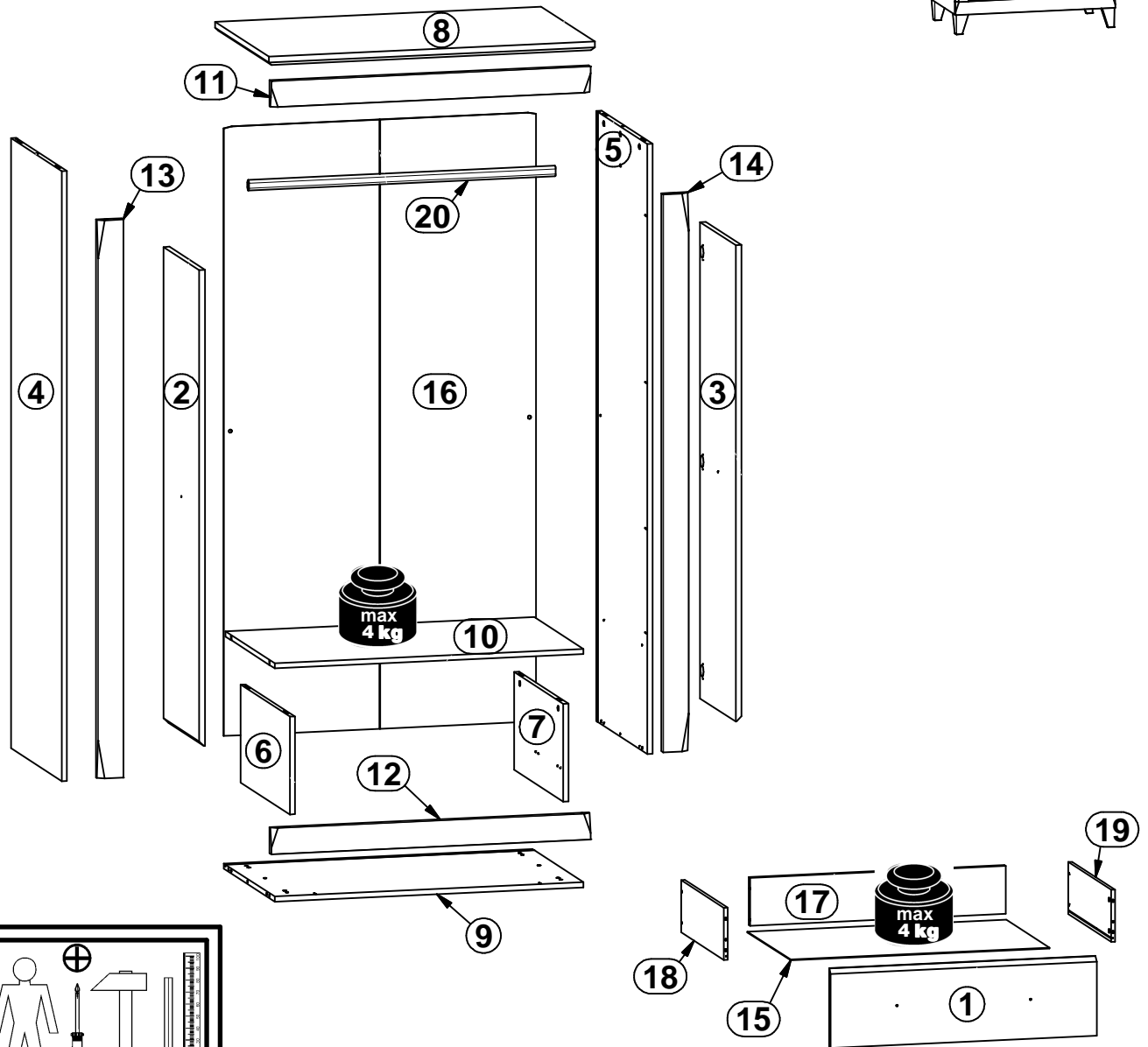
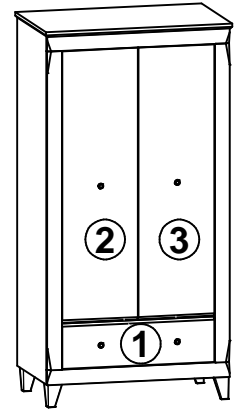
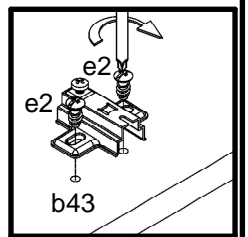
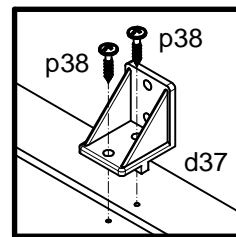
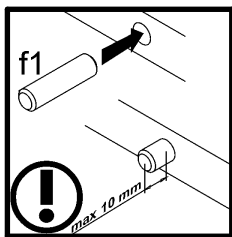
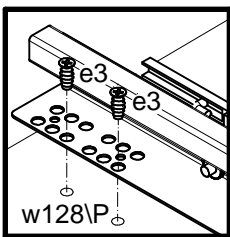
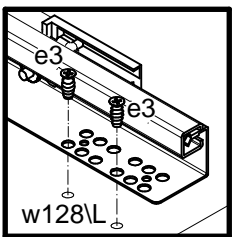
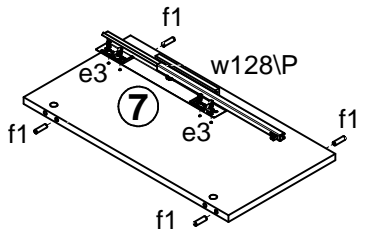
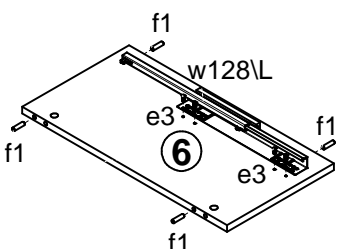
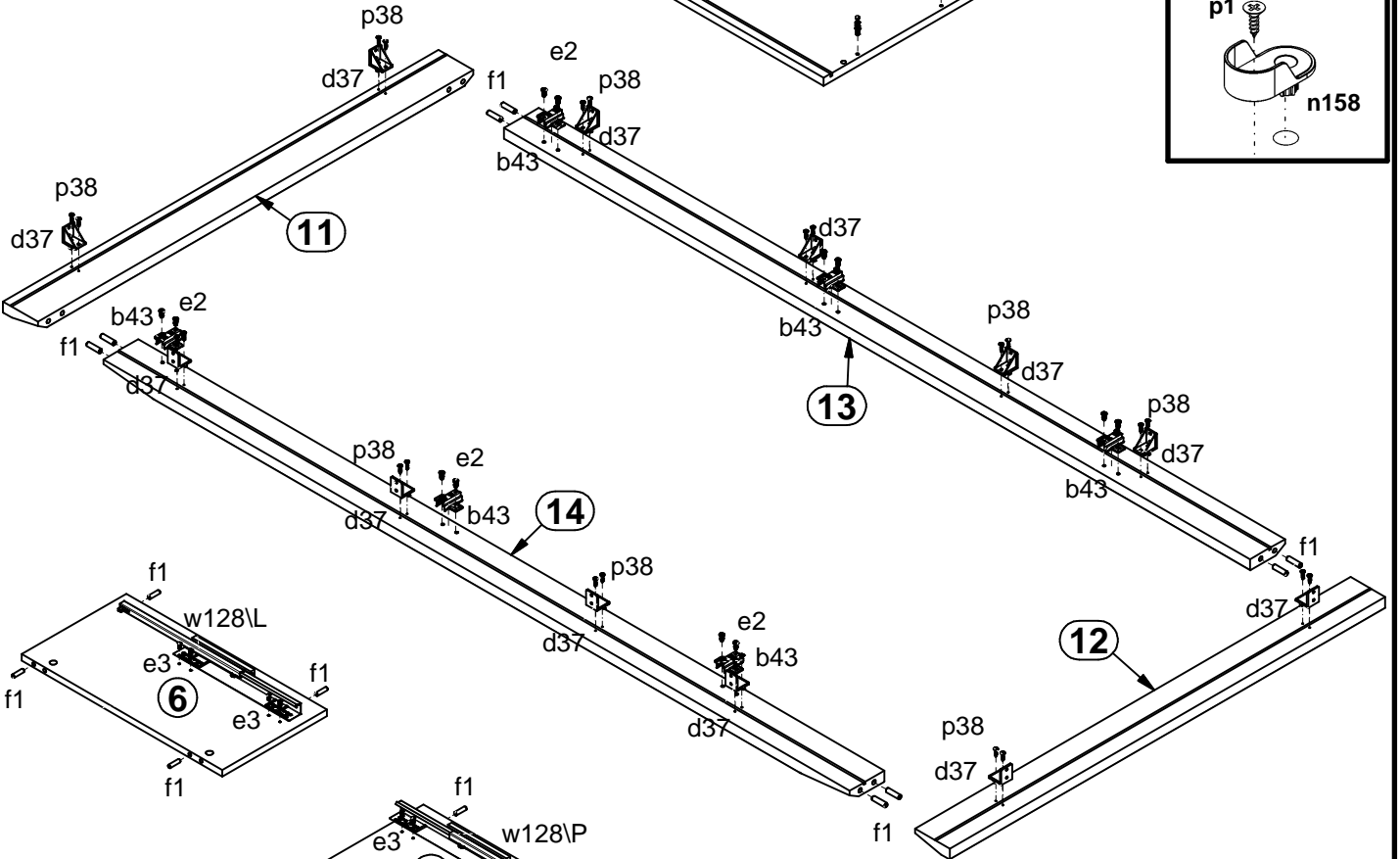
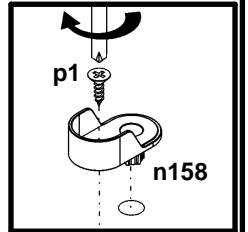
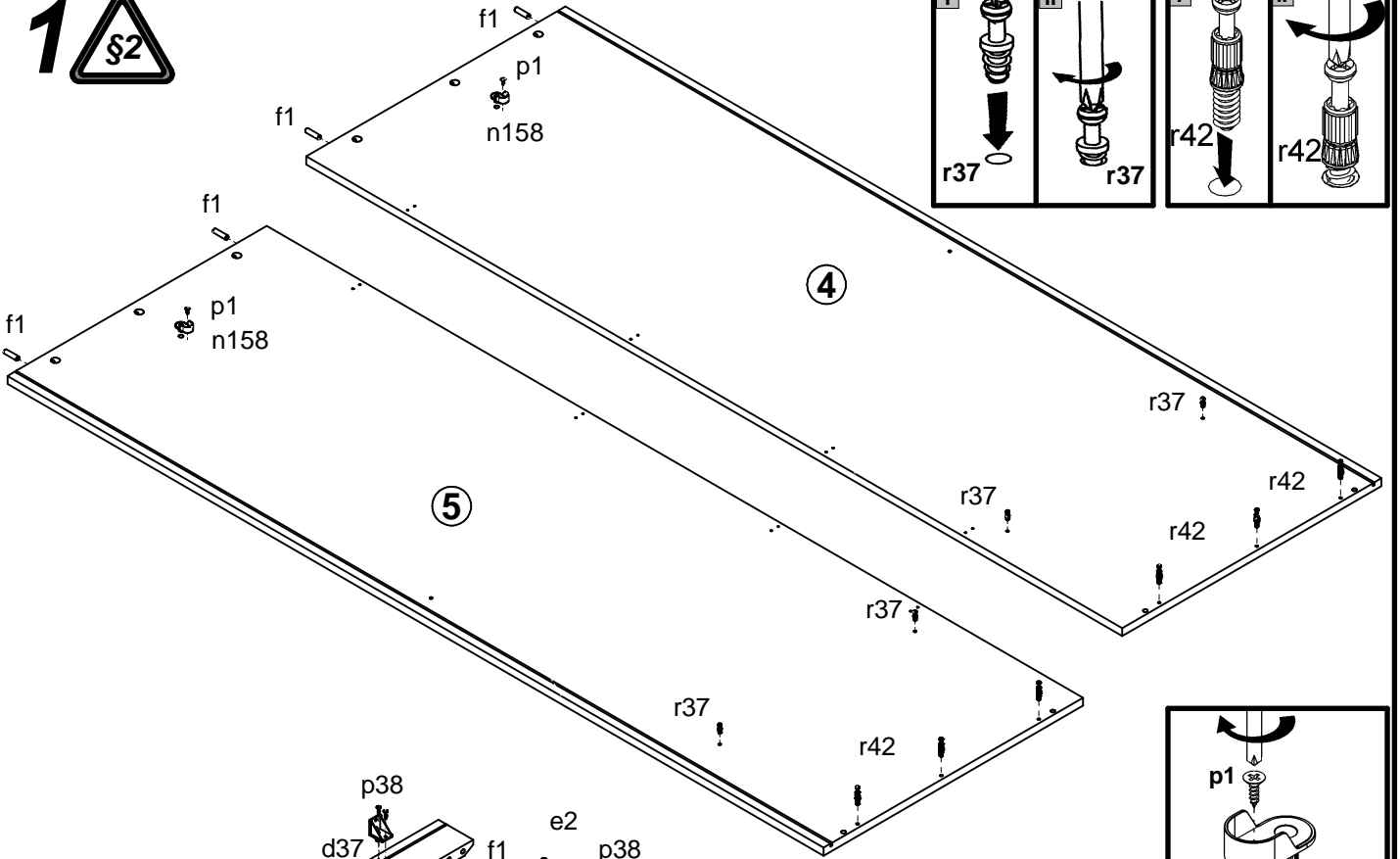
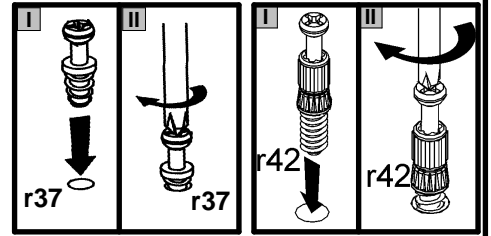

# 2

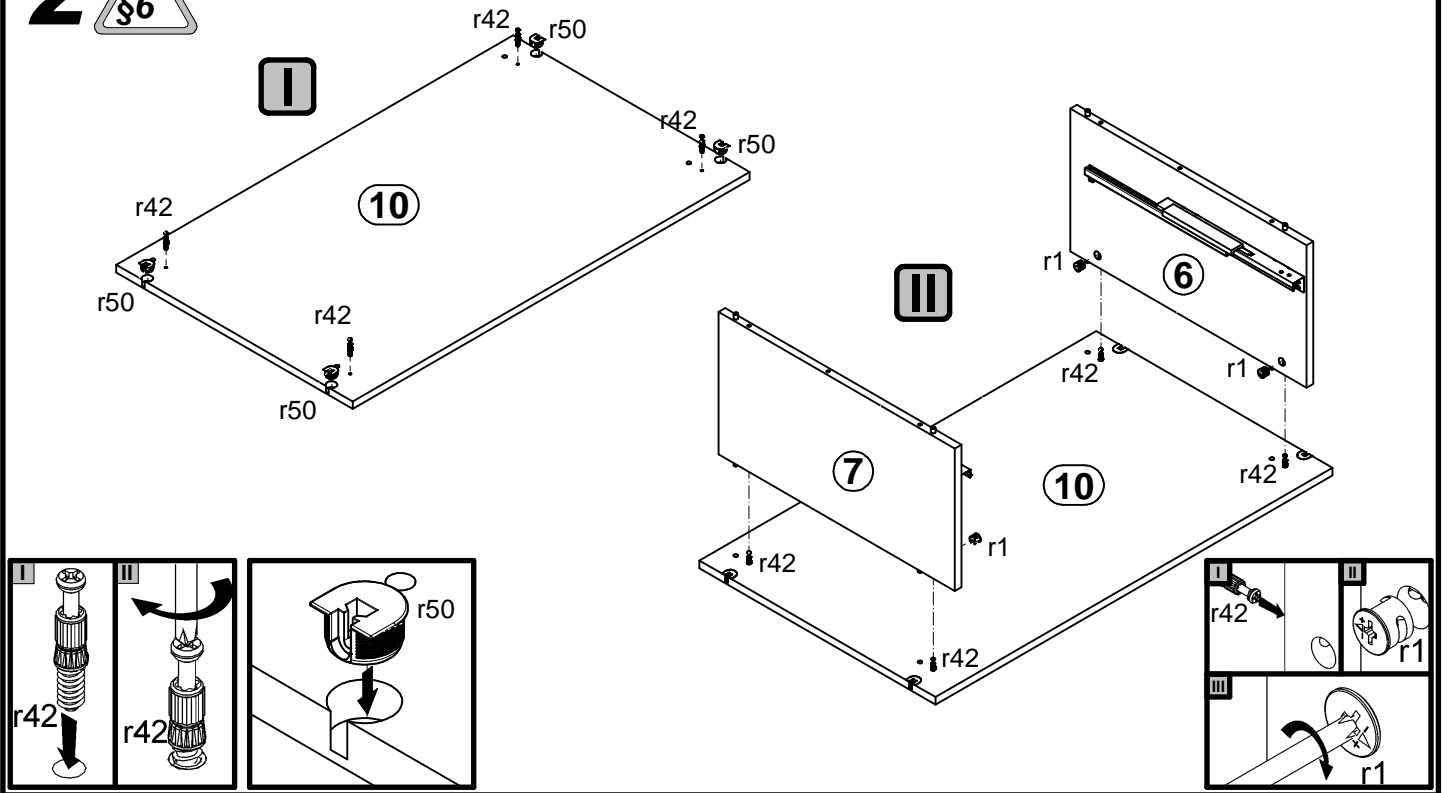

# 3

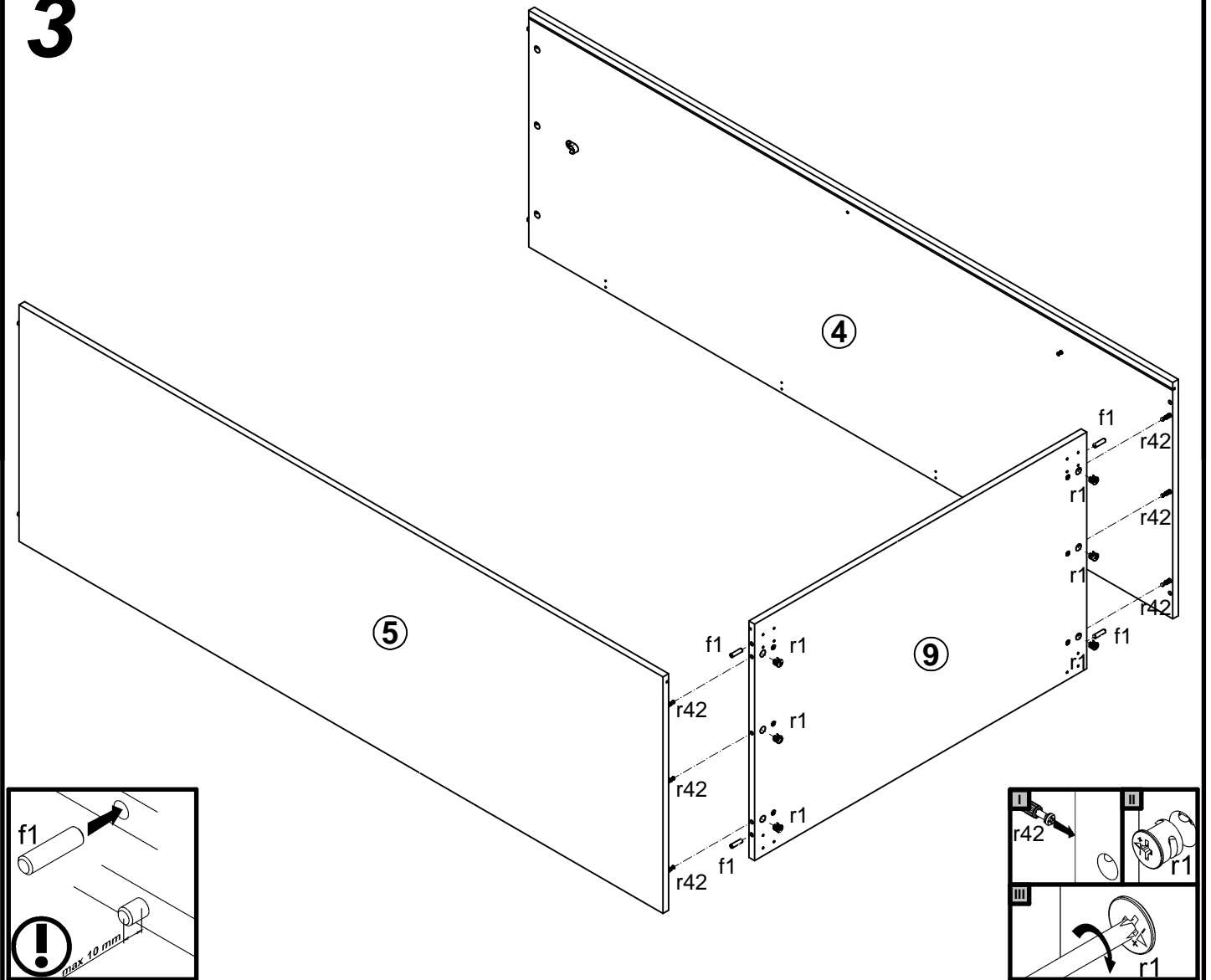

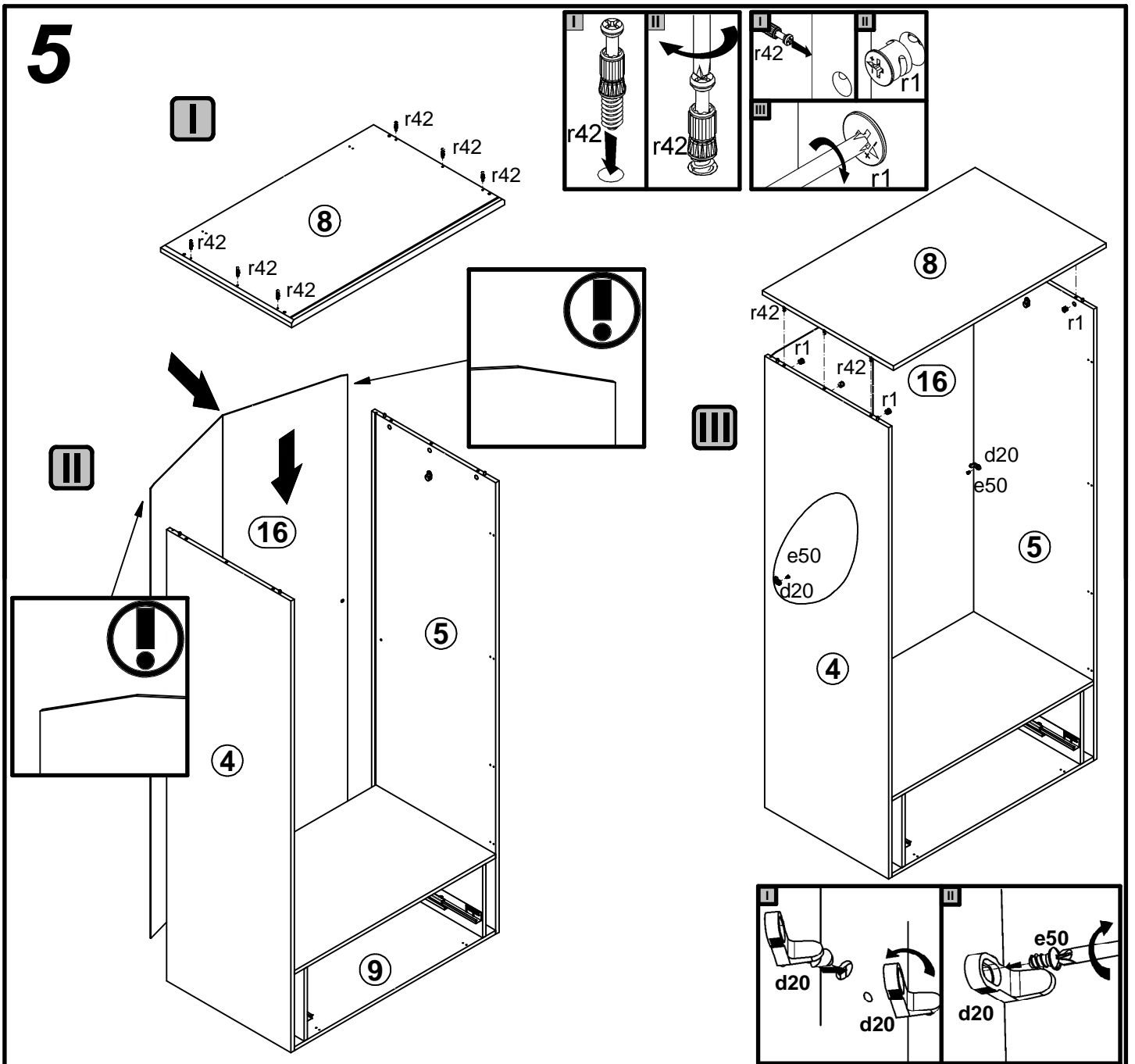
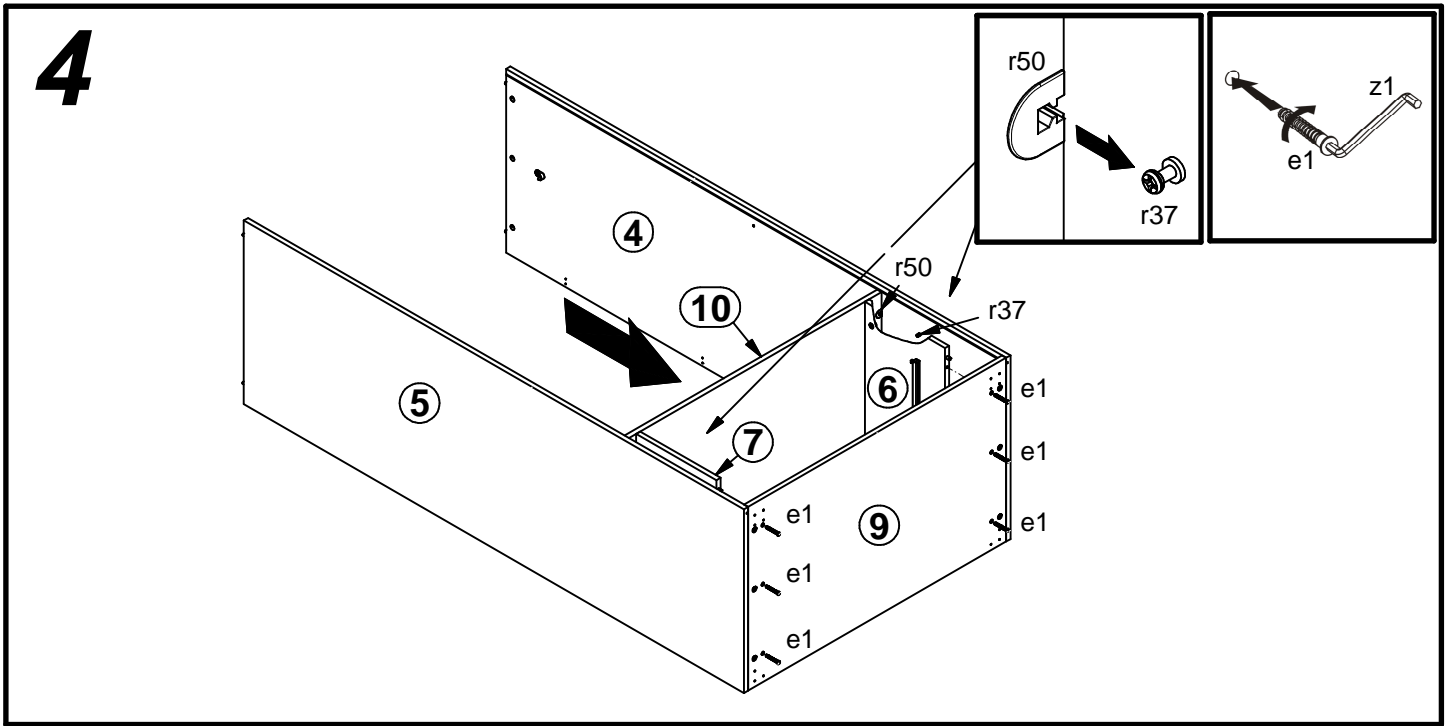

# 6

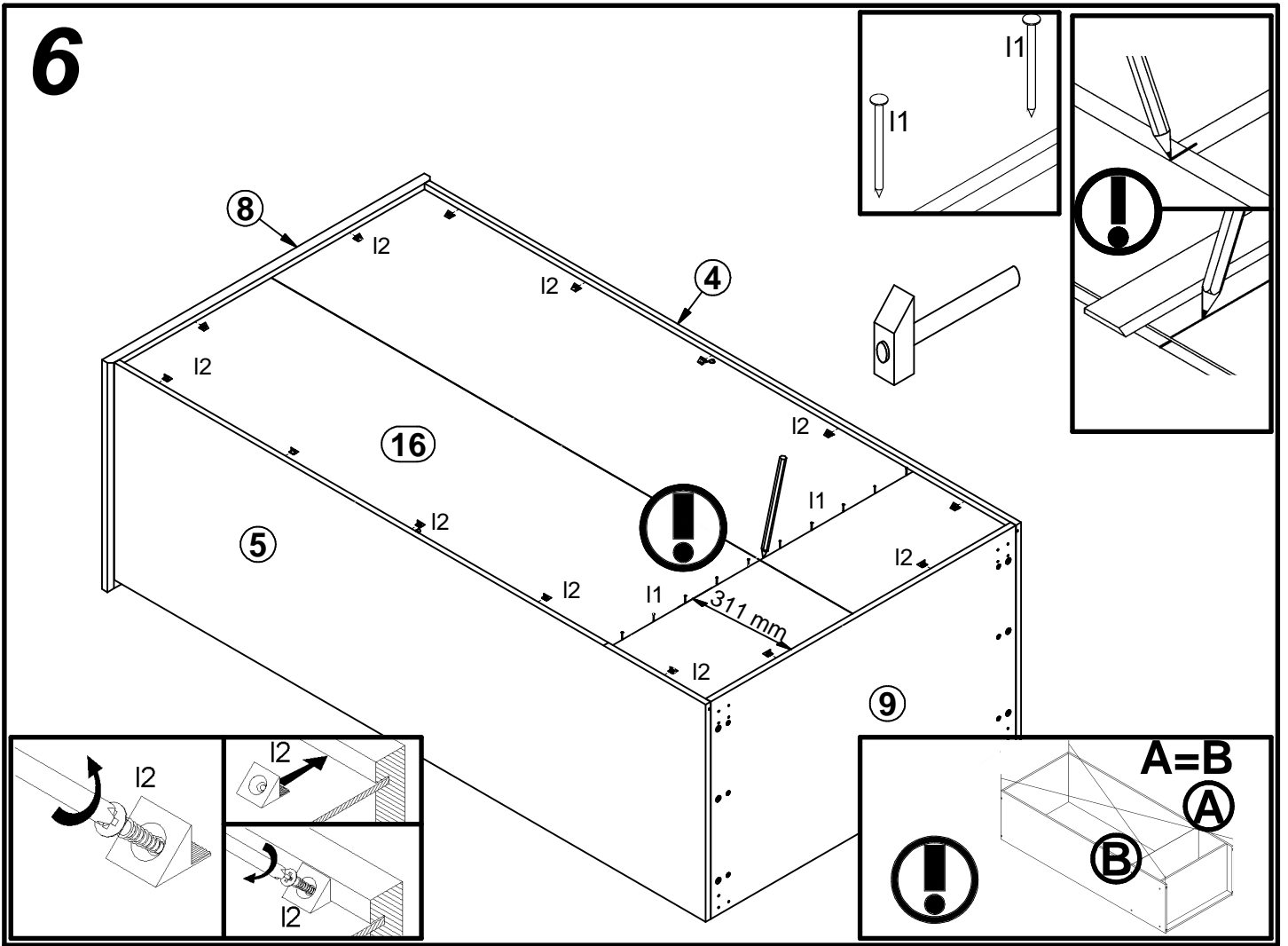

# 7

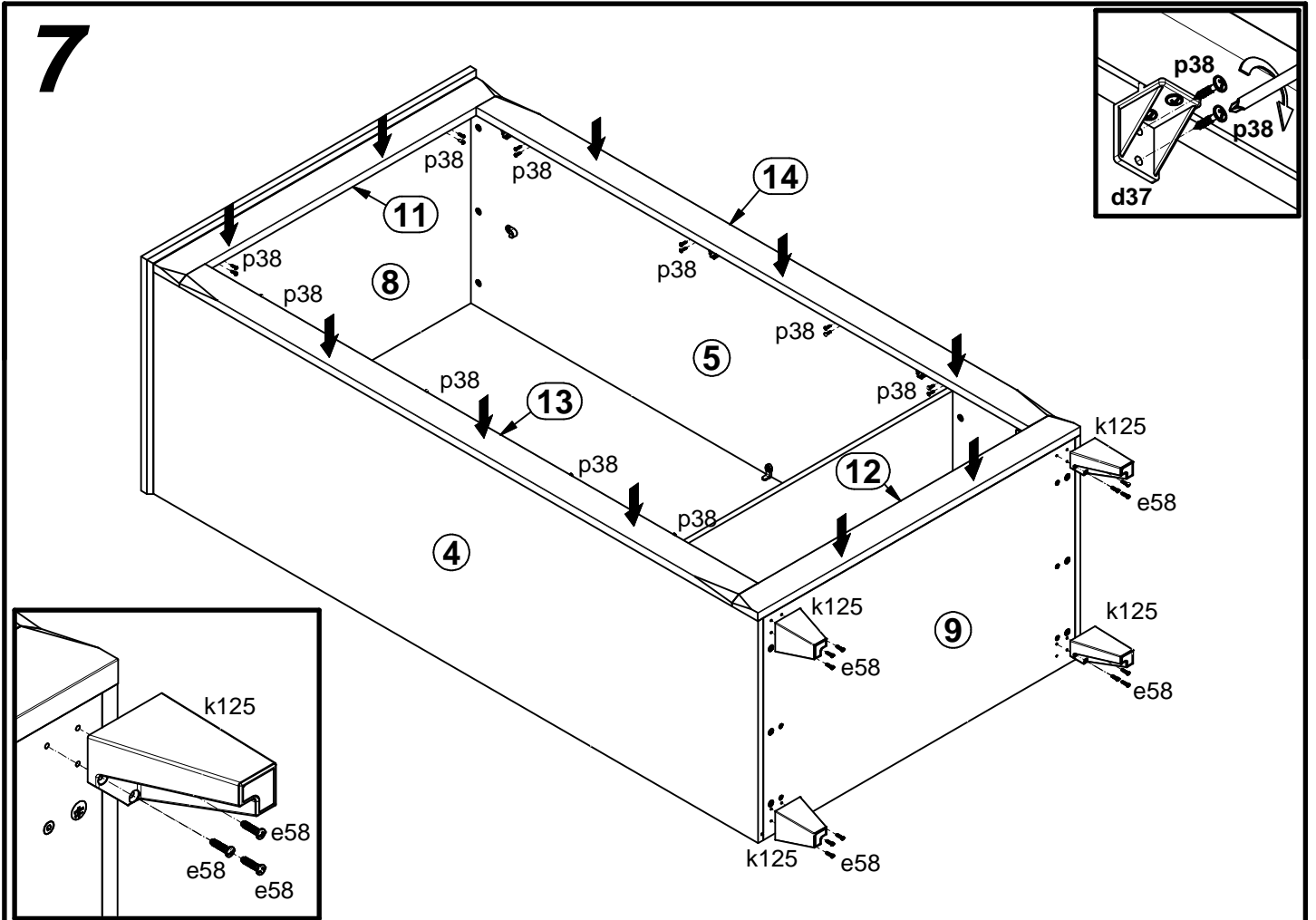

# 8

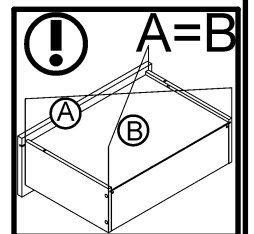
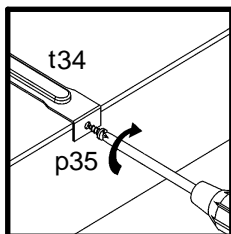
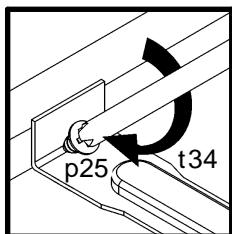
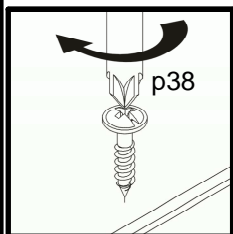
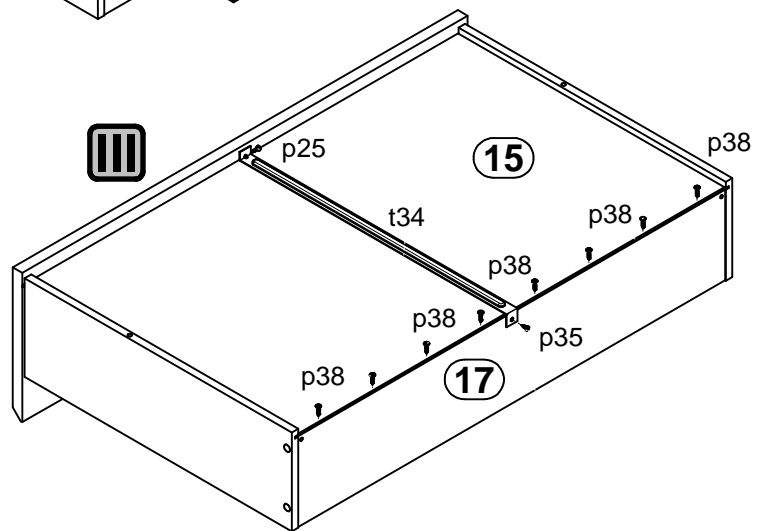
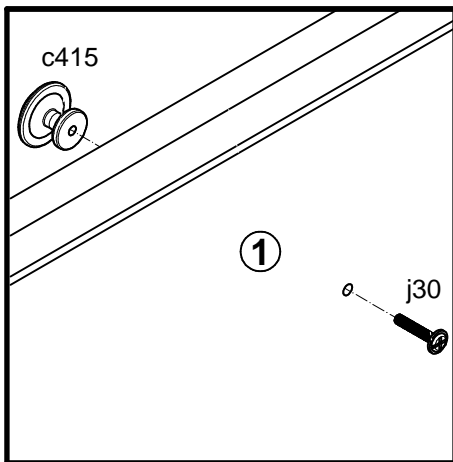
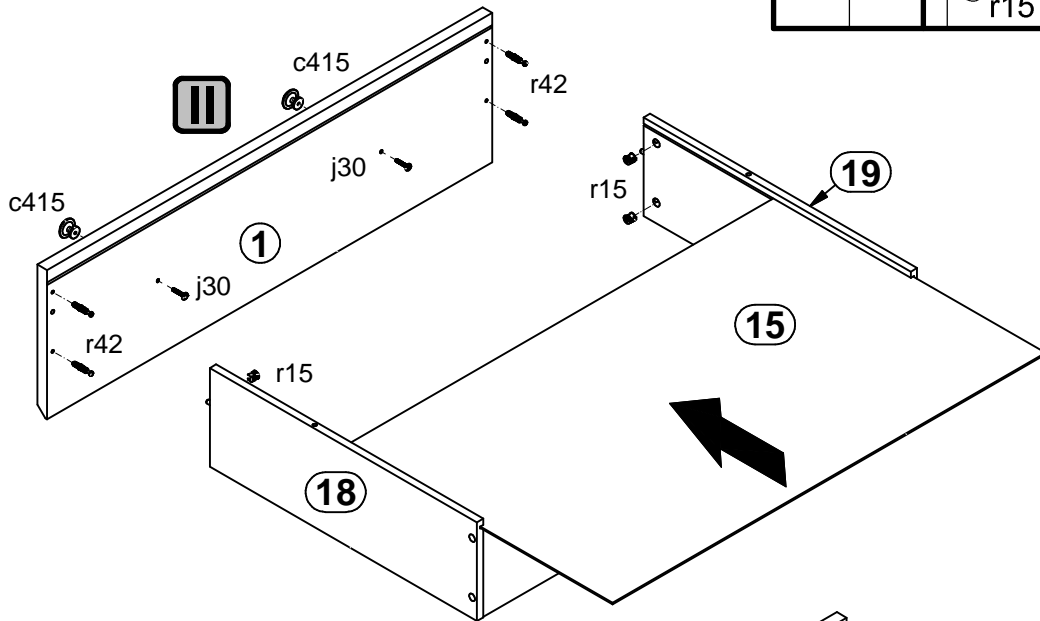
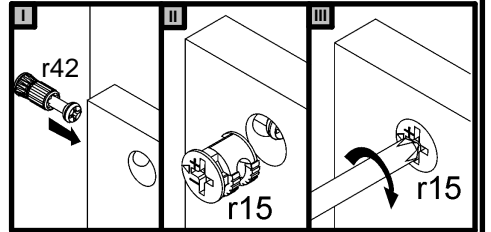
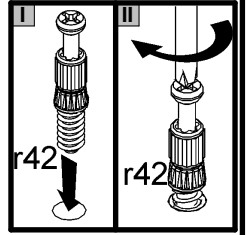
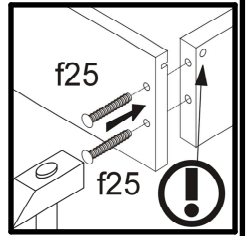
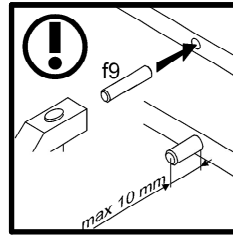
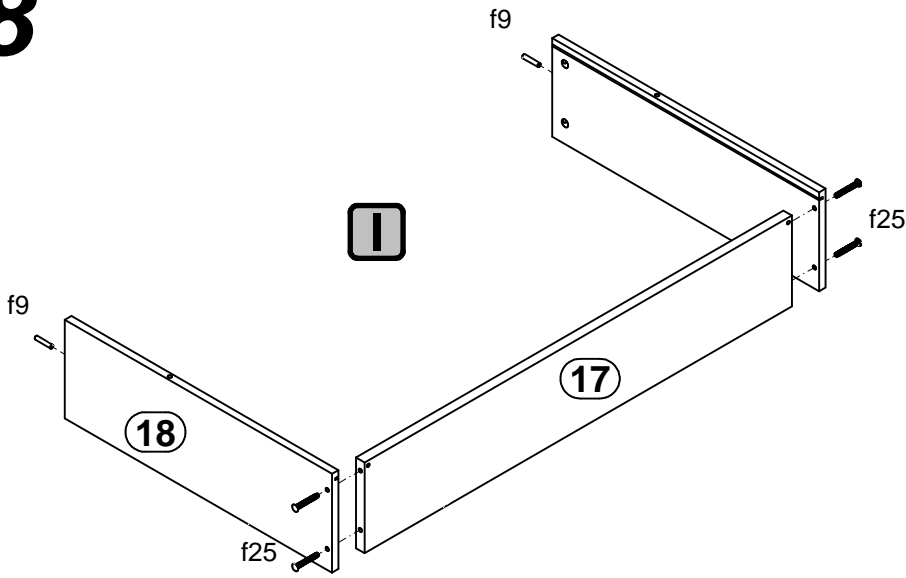

# 9

