

<http://www.bega-gruppe.de>

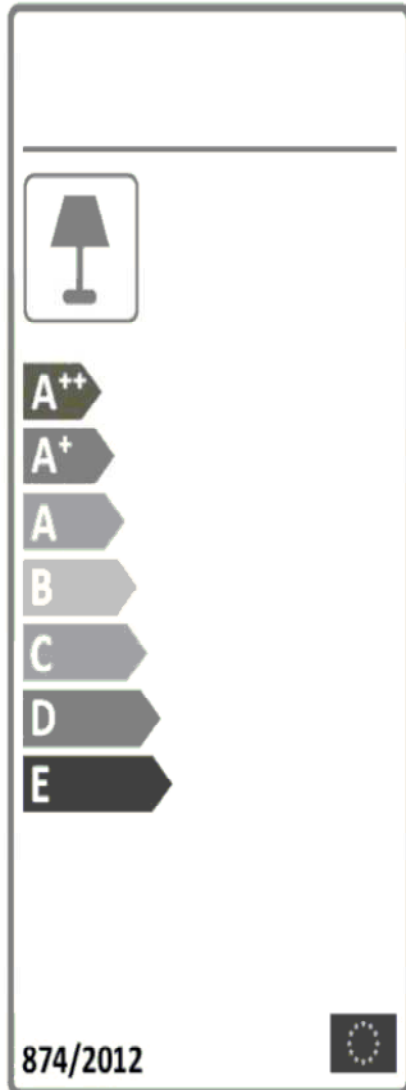

BG	Bulgarisch	български
CS	Tschechisch	čeština
DA	Dänisch	Dansk
DE	Deutsch	Deutsch
ET	Estnisch	Eesti
EL	Griechisch	ελληνικά
EN	Englisch	English
ES	Spanisch	español
FR	Französisch	Français
FI	Finnisch	suomalainen
HR	Kroatisch	hrvatski
HU	Ungarisch	magyar
IT	Italienisch	Italiano
LV	Lettisch	Latvijas
LT	Litauisch	Lietuvos
NL	Niederländisch	Nederlands
PL	Polnisch	Polski
PT	Portugiesisch	português
RO	Rumänisch	român
SK	Slowakisch	slovenský
SL	Slowenisch	slovenščina
SV	Schwedisch	Svenska

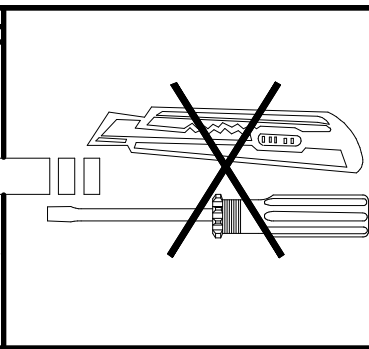

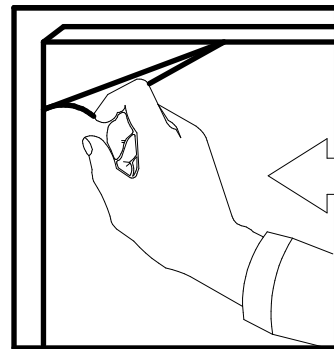
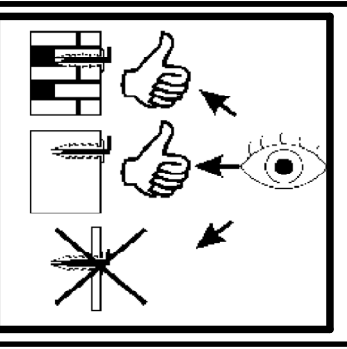
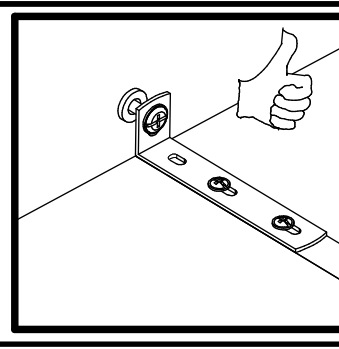
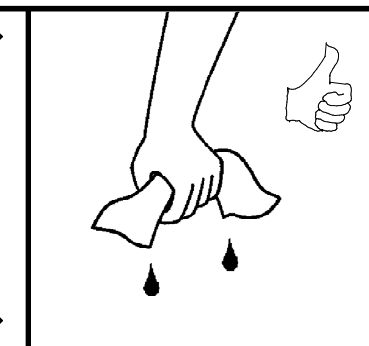
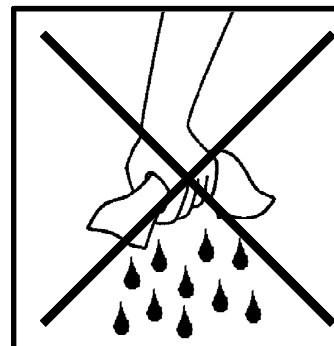
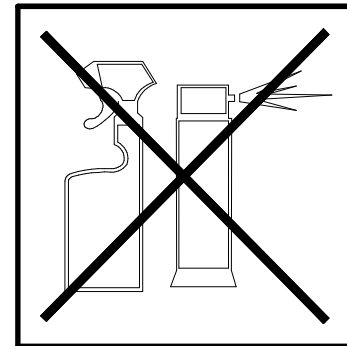
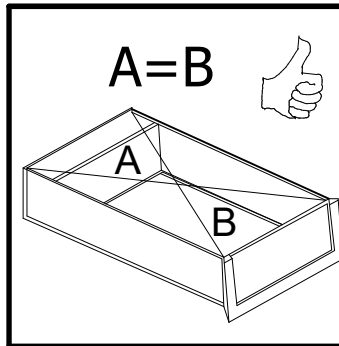
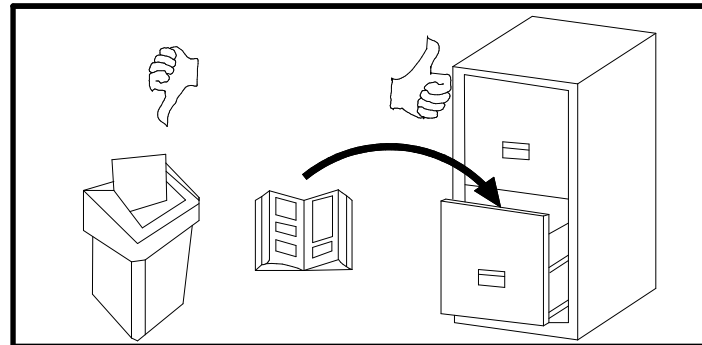
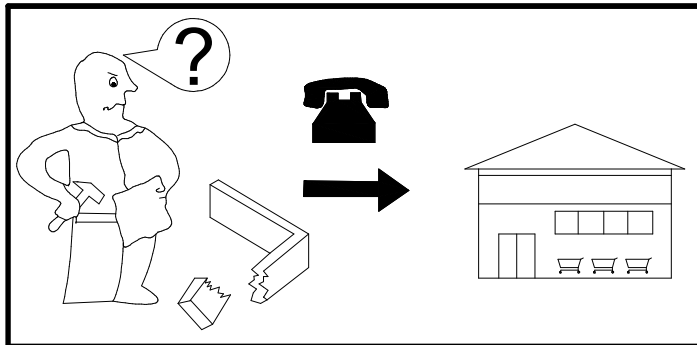
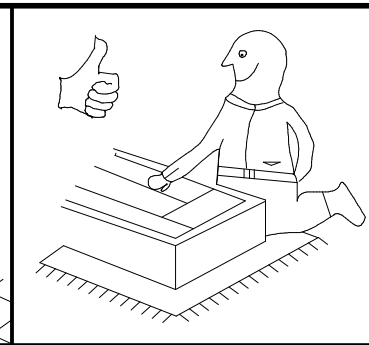
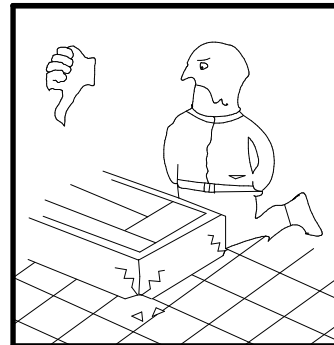
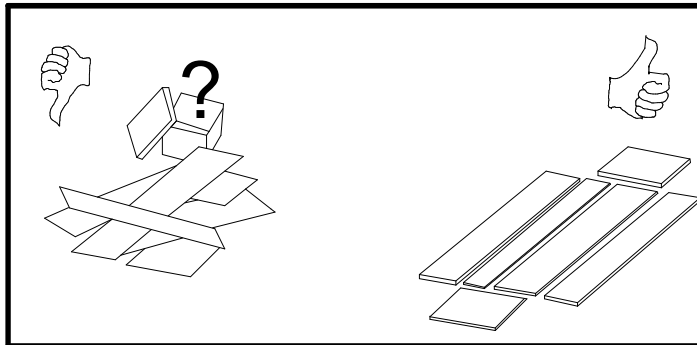
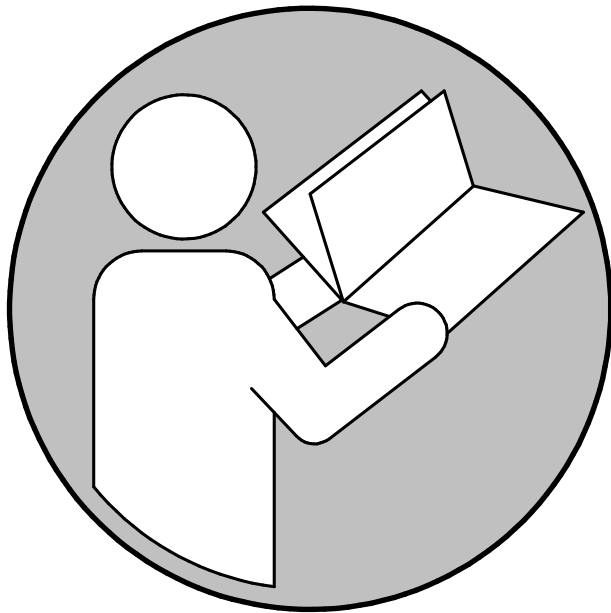

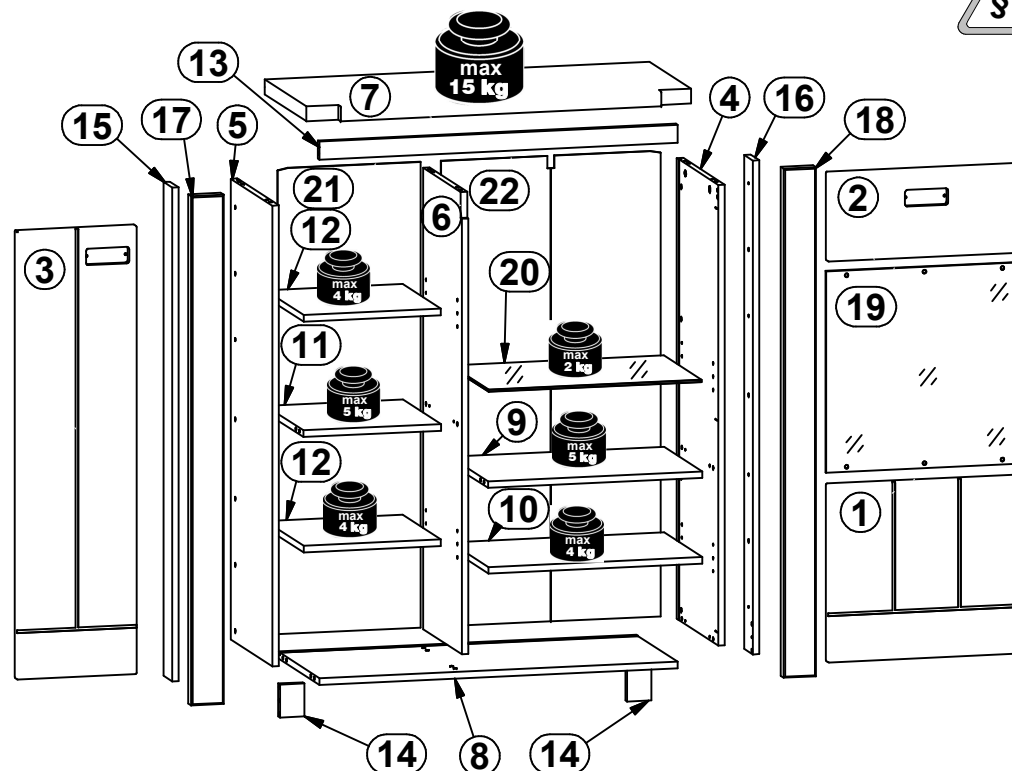
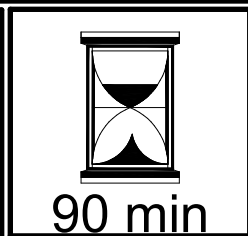
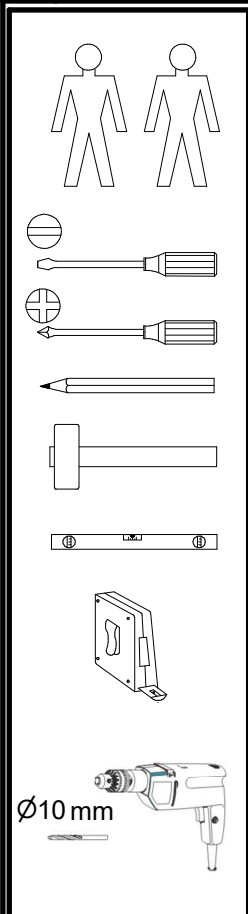

A	B	C (mm)		D
1	S378-0005	430	486	3/4
2	S378-0006	215	486	3/4
3	S378-0007	1084	296	2/4
4	S378-1004	1114	382	1/4
5	S378-1005	1114	382	1/4
6	S378-1006	1116	356	1/4
7	S378-2002	948	405	1/4
8	S378-3004	883	382	1/4
9	S378-3005	528	350	3/4
10	S378-3006	527	350	3/4
11	S378-3007	339	350	2/4
12	S378-3008	338	350	2/4
13	S378-4002	883	44	2/4
14	S378-5005	80	60	4/4
15	S378-5006	1194	80	4/4
16	S378-5007	1194	80	4/4
17	S378-5008	1231	80	4/4
18	S378-5009	1231	80	4/4
19	S378-5053	487	485	3/4
20	S378-5054	526	345	3/4
21	S378-9004	1126	352	1/4
22	S378-9303	1126	541	1/4

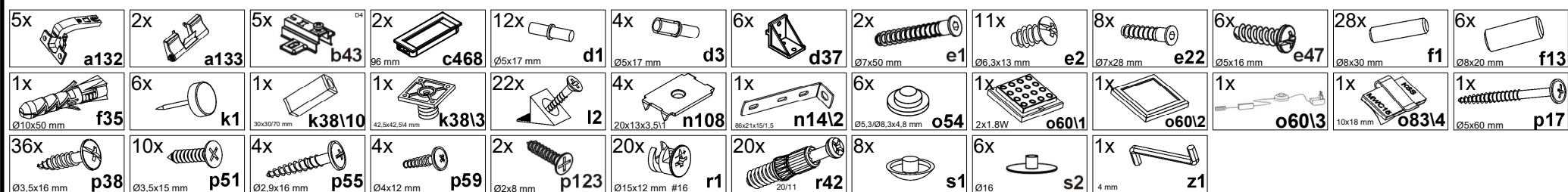

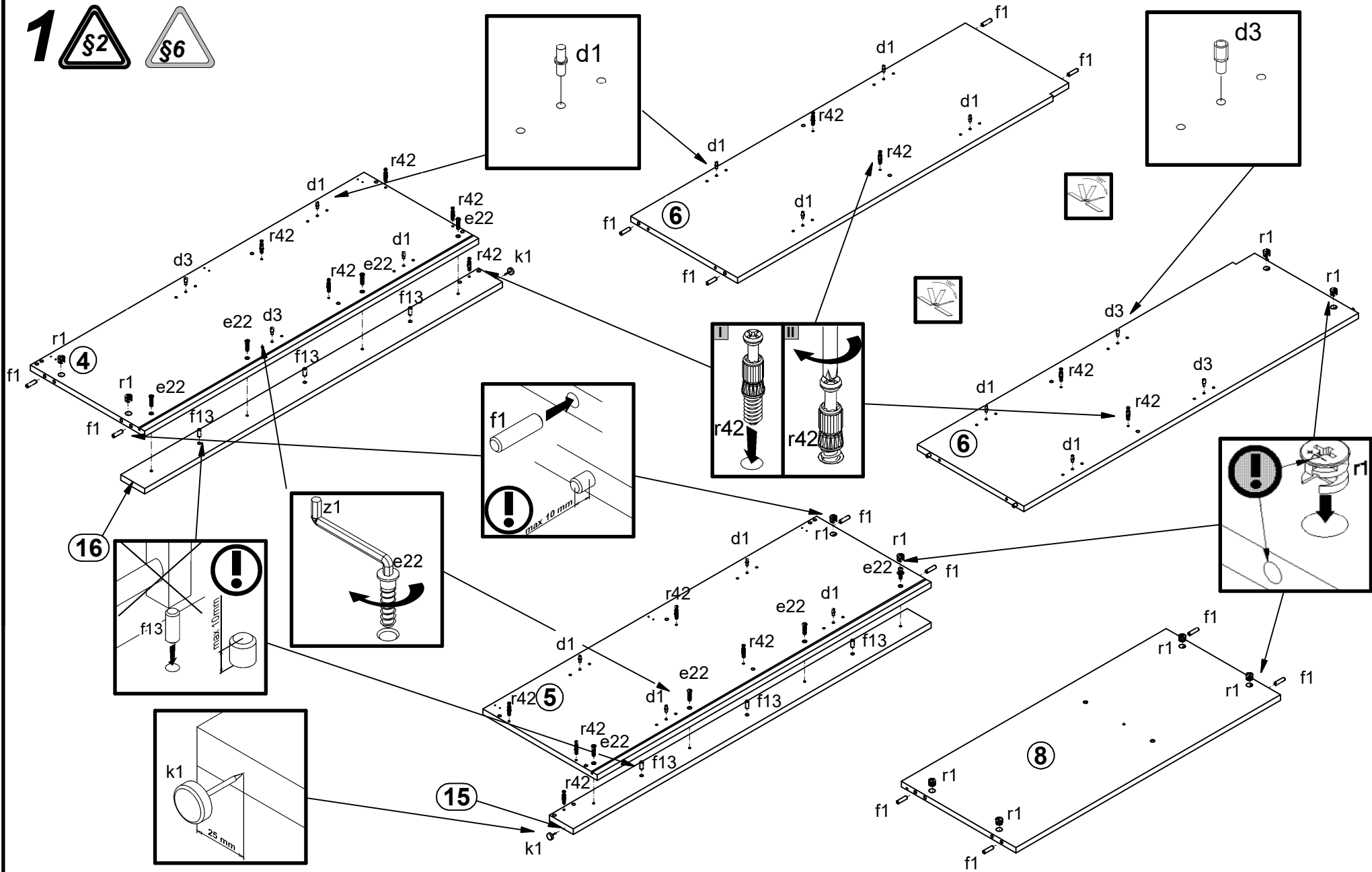





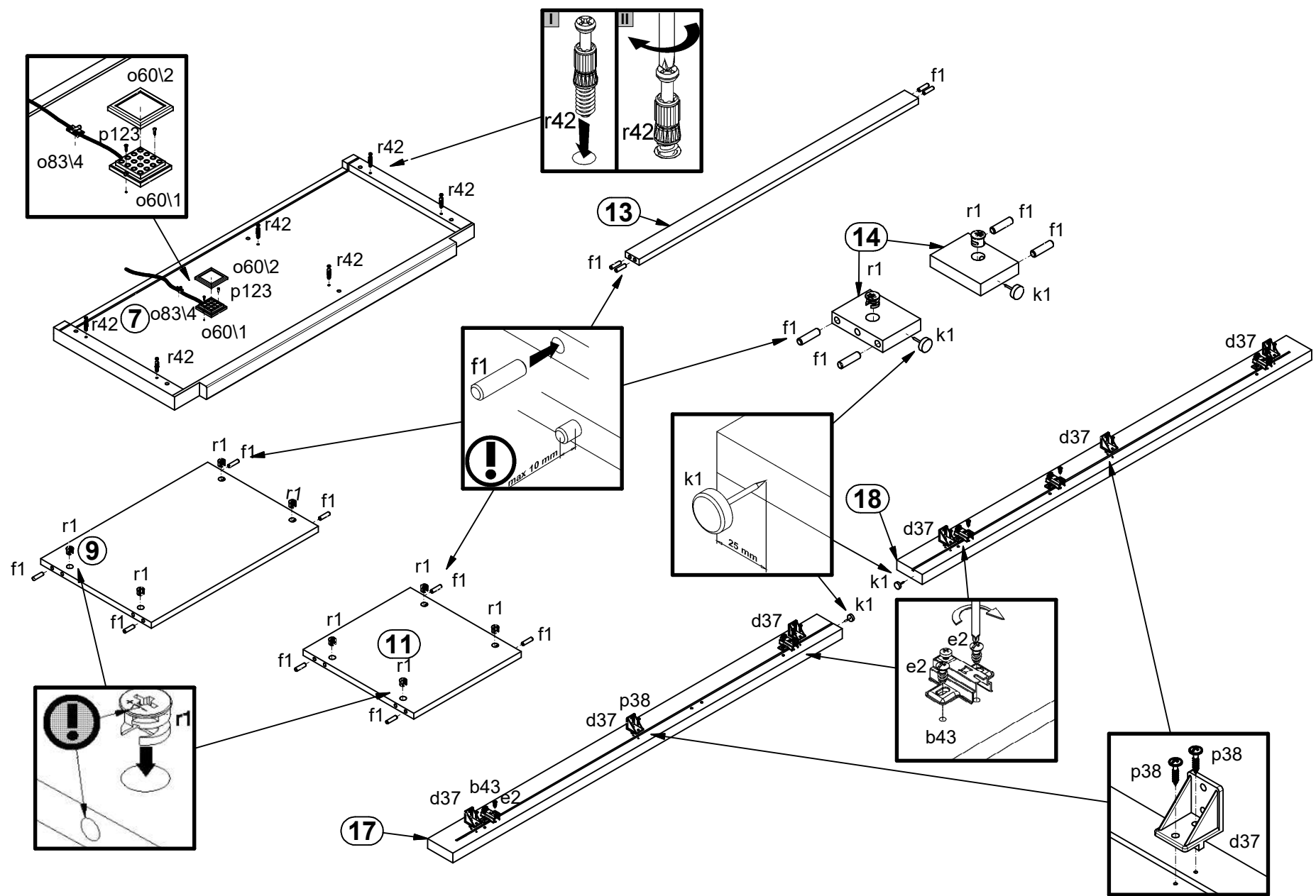







12x Ø5x17 mm d1	4x Ø5x17 mm d3	8x Ø7x28 mm e22	12x Ø8x30 mm f1	6x Ø8x20 mm f13	2x k1	10x Ø15x12 mm #16 r1	14x 20/11 r42	1x 4 mm z1
-----------------------	----------------------	-----------------------	-----------------------	-----------------------	----------	----------------------------	---------------------	------------------

2 §2



- 5x  b43
- 6x  d37
- 10x  e2
Ø6,3x13 mm
- 16x  f1
Ø8x30 mm
- 4x  k1
- 1x  o60\1
2x1.8W
- 1x  o60\2
- 1x  o83\4
10x18 mm
- 12x  p38
Ø3,5x16 mm
- 2x  p123
Ø2x8 mm
- 10x  r1
Ø15x12 mm #16
- 6x  r42
20/11

3  

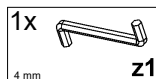
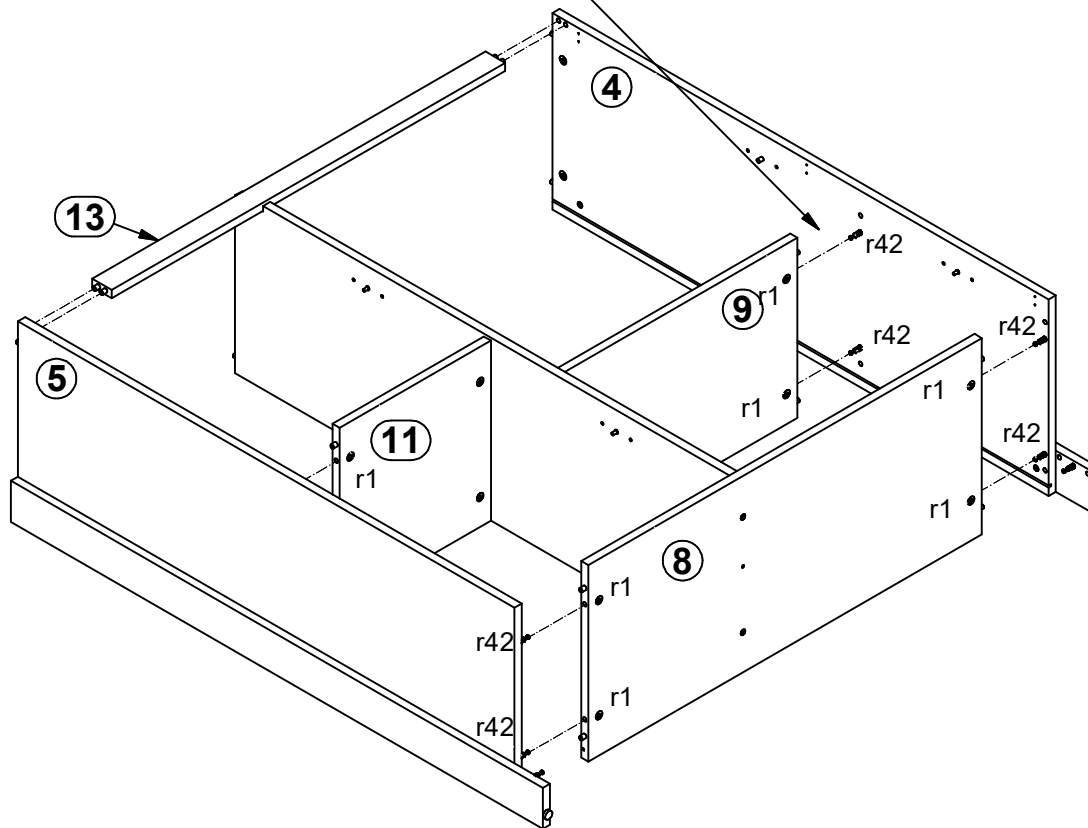
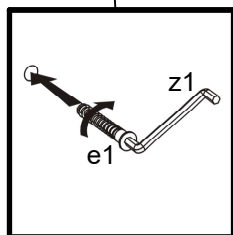
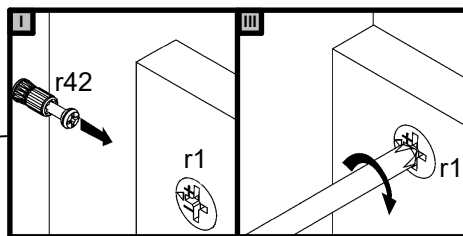
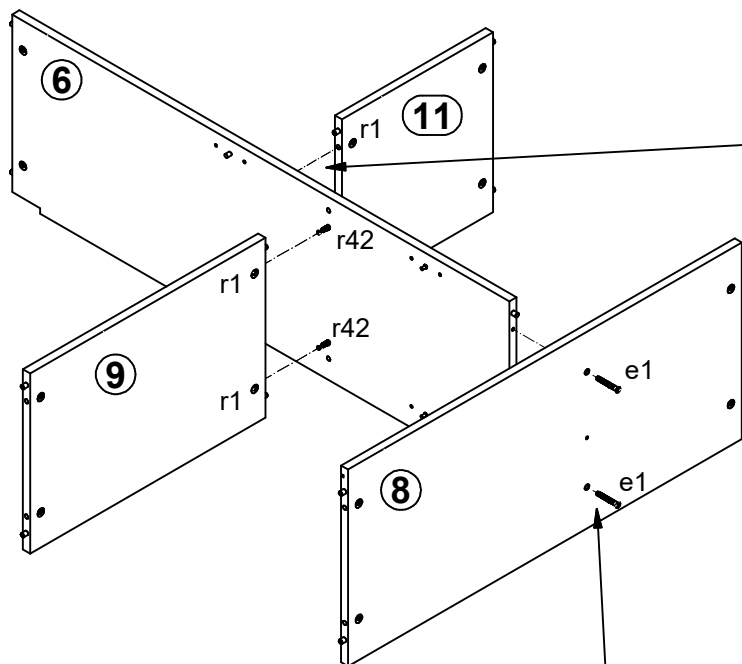

4 $\text{§}2$ $\text{§}6$

A=B





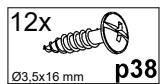
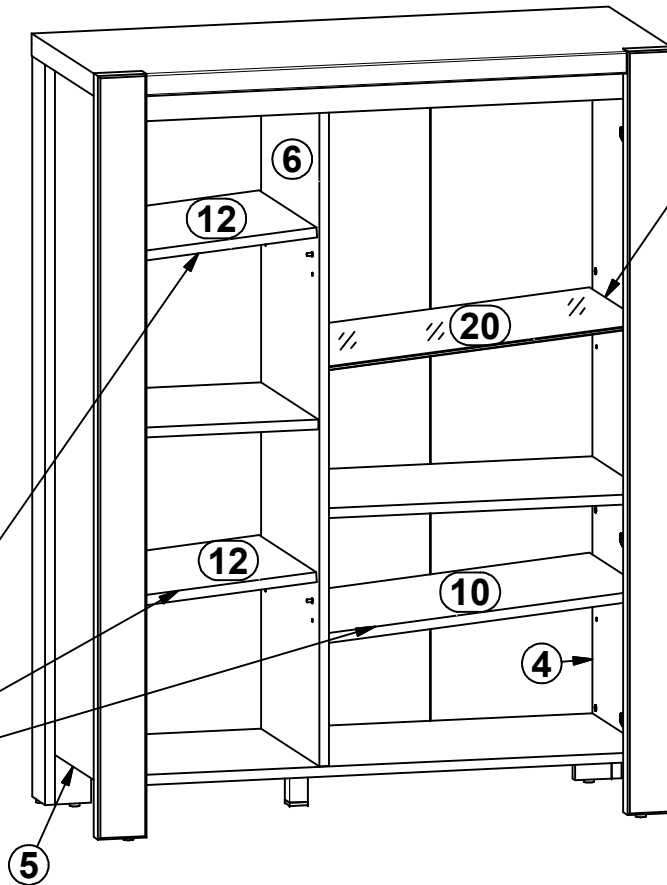
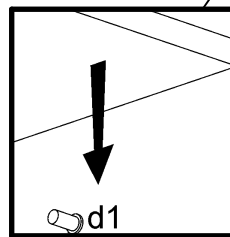
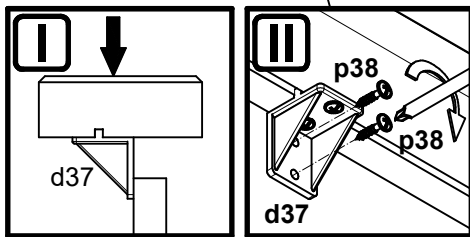
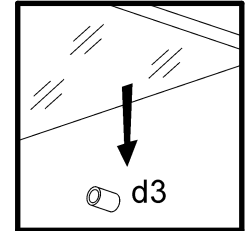
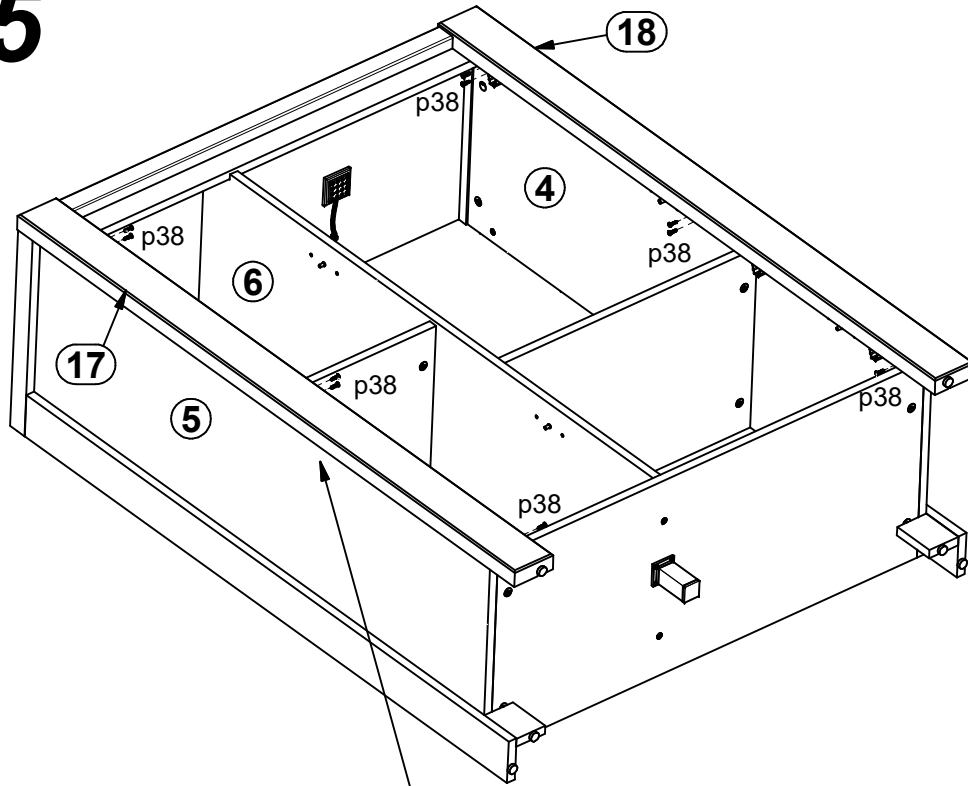

1x		1x		1x		22x		4x		10x		4x	
	$\text{Ø}6,3 \times 13 \text{ mm}$		$42,5 \times 42,54 \text{ mm}$		$30 \times 30,70 \text{ mm}$		I2		$20 \times 13 \times 3,51$		$\text{Ø}3,5 \times 16 \text{ mm}$		$\text{Ø}2,9 \times 16 \text{ mm}$

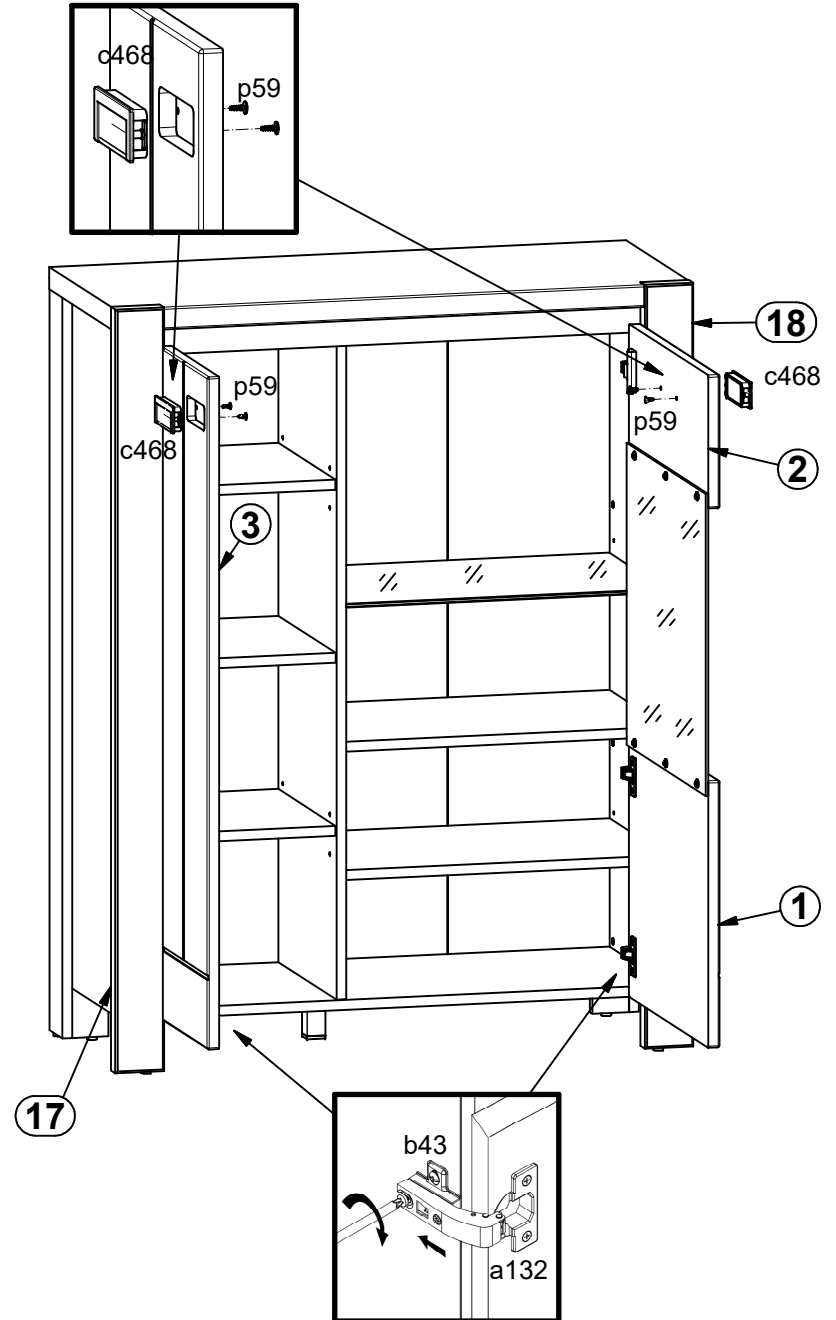
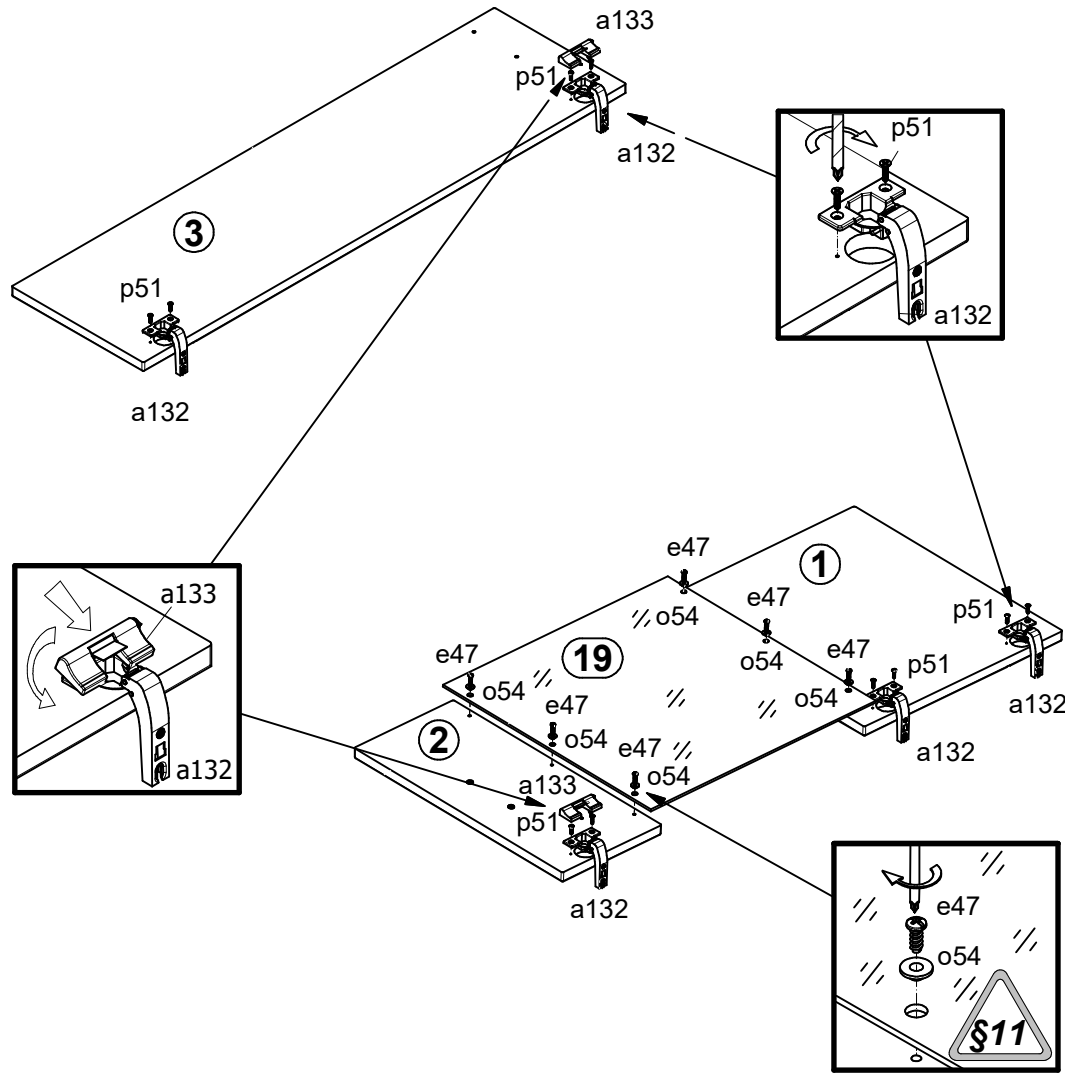
5



6 §6



- 5x  a132
- 2x  a133
- 2x  c468 96 mm
- 6x  e47 Ø5,3/Ø8,3x4,8 mm
- 6x  o54 Ø3,5x15 mm
- 10x  p51 Ø3,5x15 mm
- 4x  p59 Ø4x12 mm

7

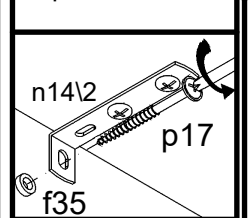
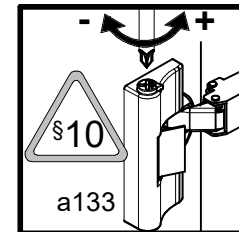
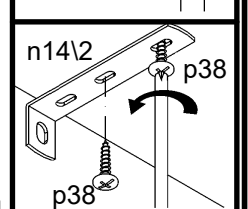
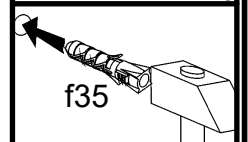
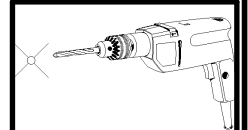
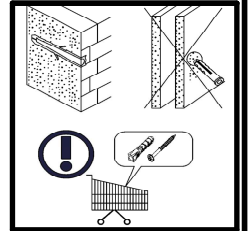
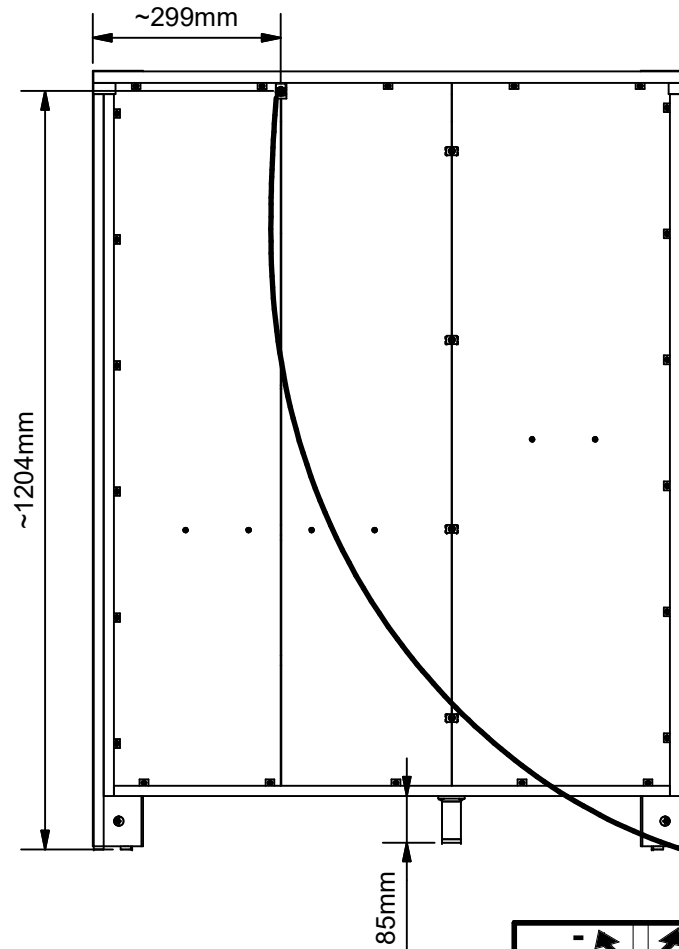
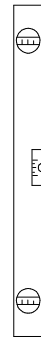
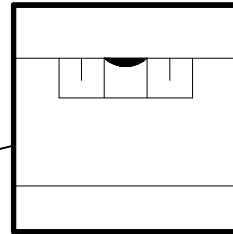
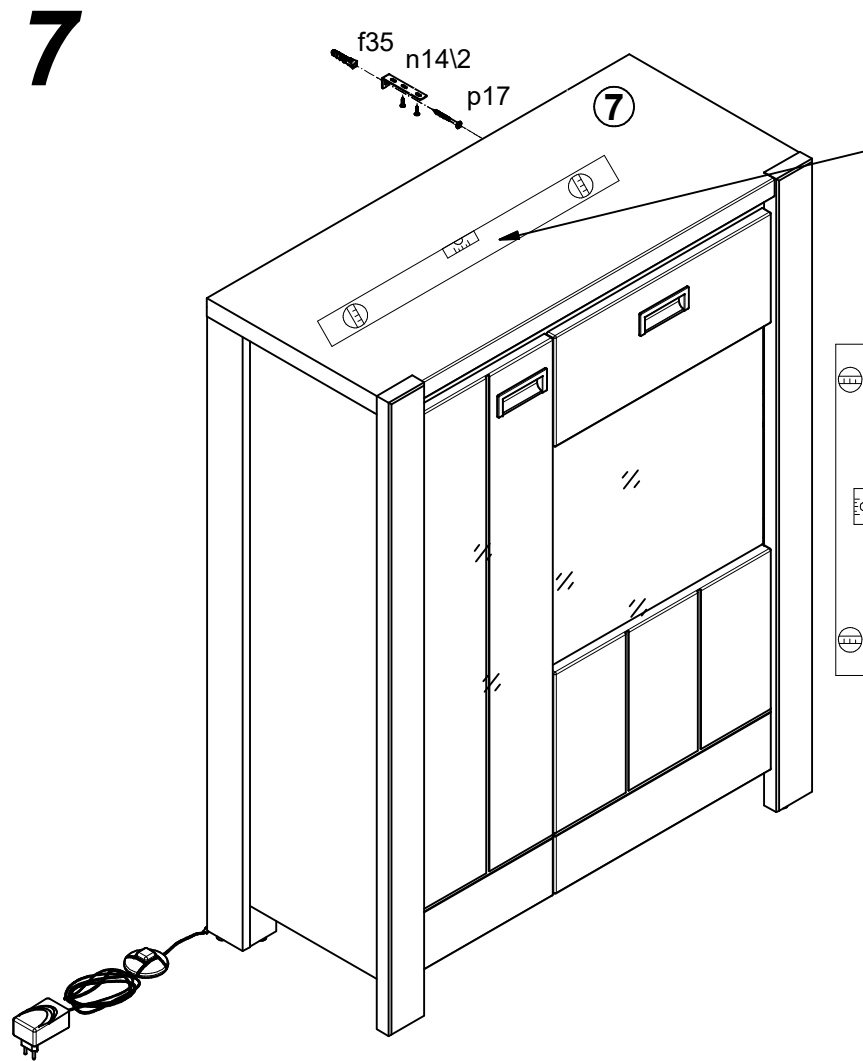

- 1x f35
- 1x n14\2
- 1x p17
- 2x p38
- 1x o60\3

