

<http://www.bega-gruppe.de>

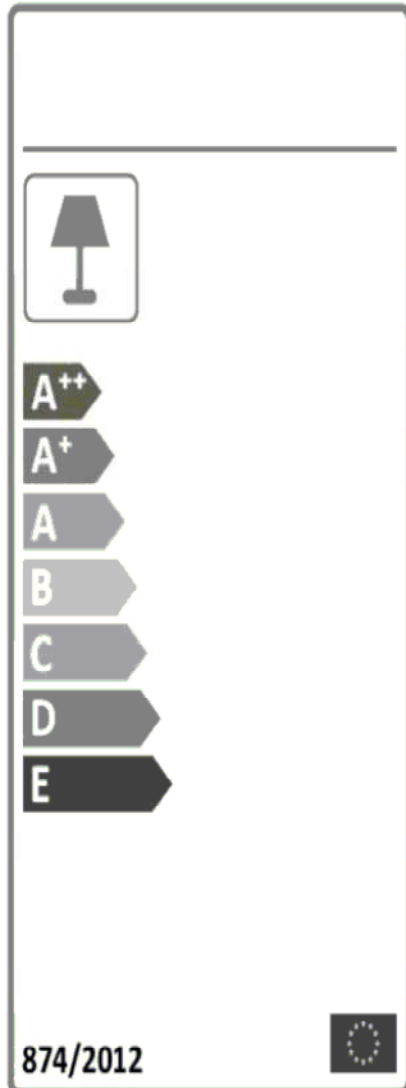

BG	Bulgarisch	български
CS	Tschechisch	čeština
DA	Dänisch	Dansk
DE	Deutsch	Deutsch
ET	Estnisch	Eesti
EL	Griechisch	ελληνικά
EN	Englisch	English
ES	Spanisch	español
FR	Französisch	Français
FI	Finnisch	suomalainen
HR	Kroatisch	hrvatski
HU	Ungarisch	magyar
IT	Italienisch	Italiano
LV	Lettisch	Latvijas
LT	Litauisch	Lietuvos
NL	Niederländisch	Nederlands
PL	Polnisch	Polski
PT	Portugiesisch	português
RO	Rumänisch	român
SK	Slowakisch	slovenský
SL	Slowenisch	slovenščina
SV	Schwedisch	Svenska

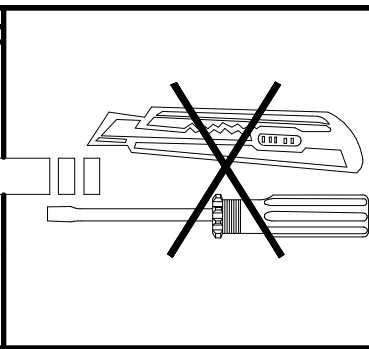

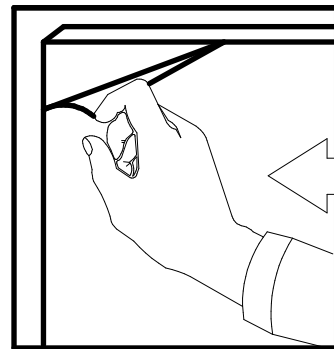
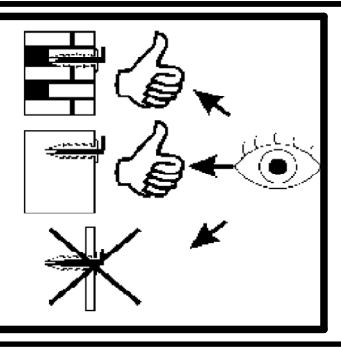
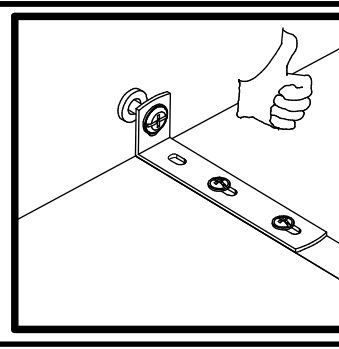
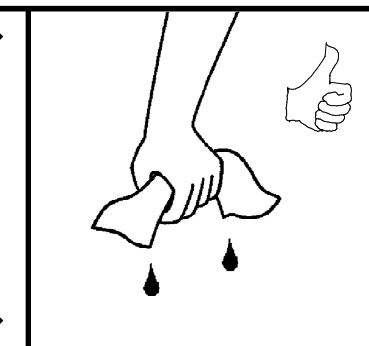
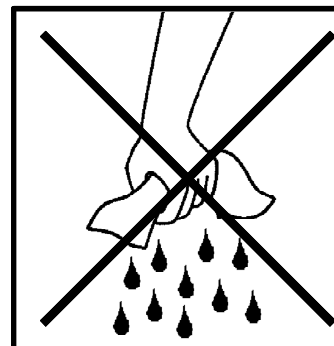
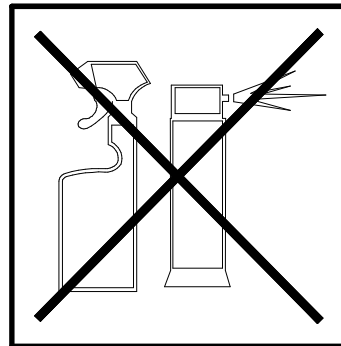
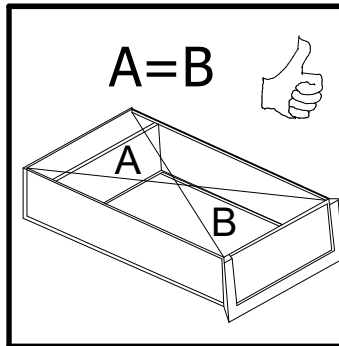
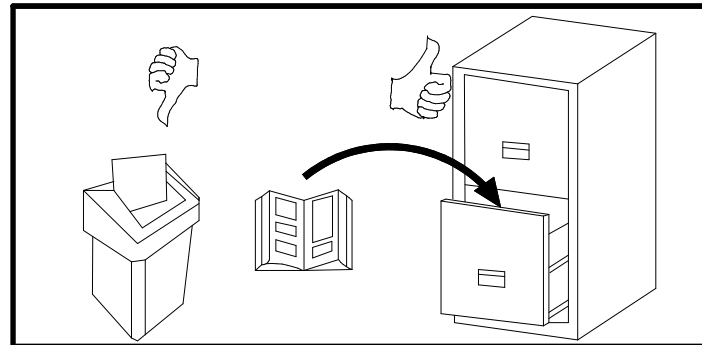
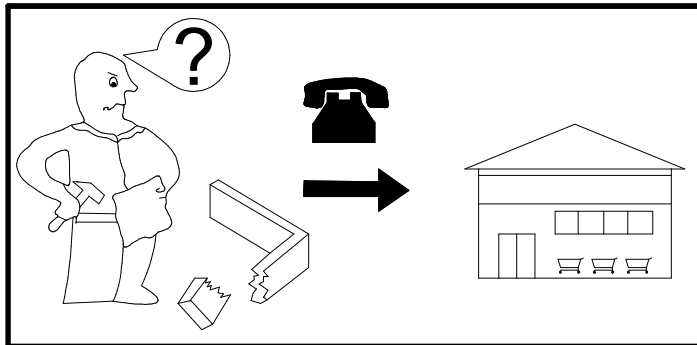
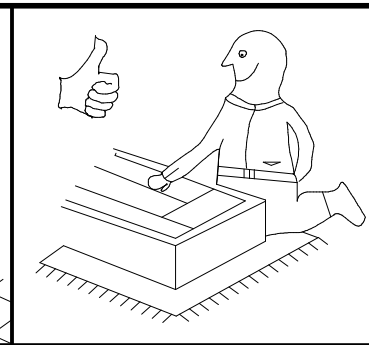
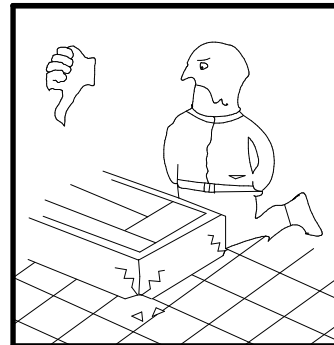
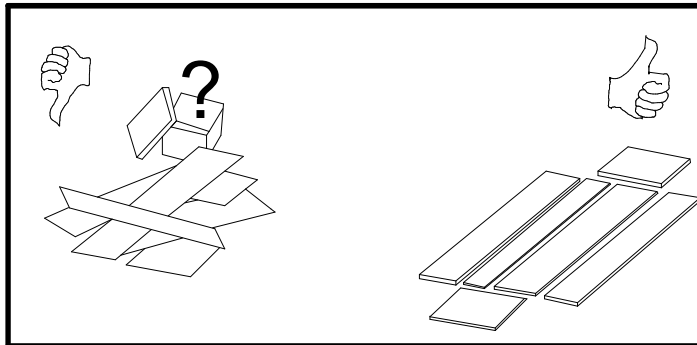
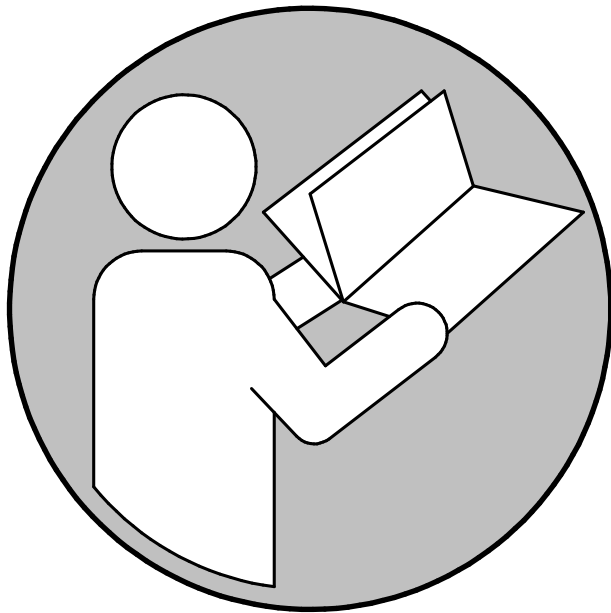

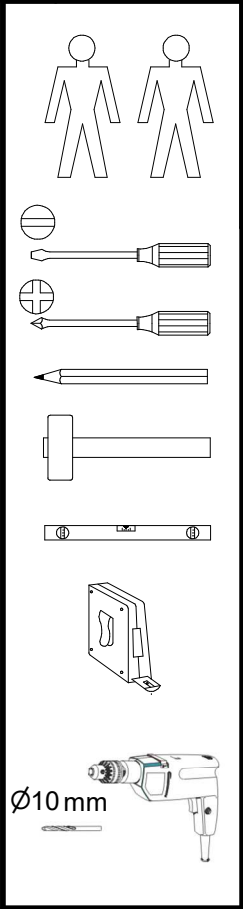

90 min.

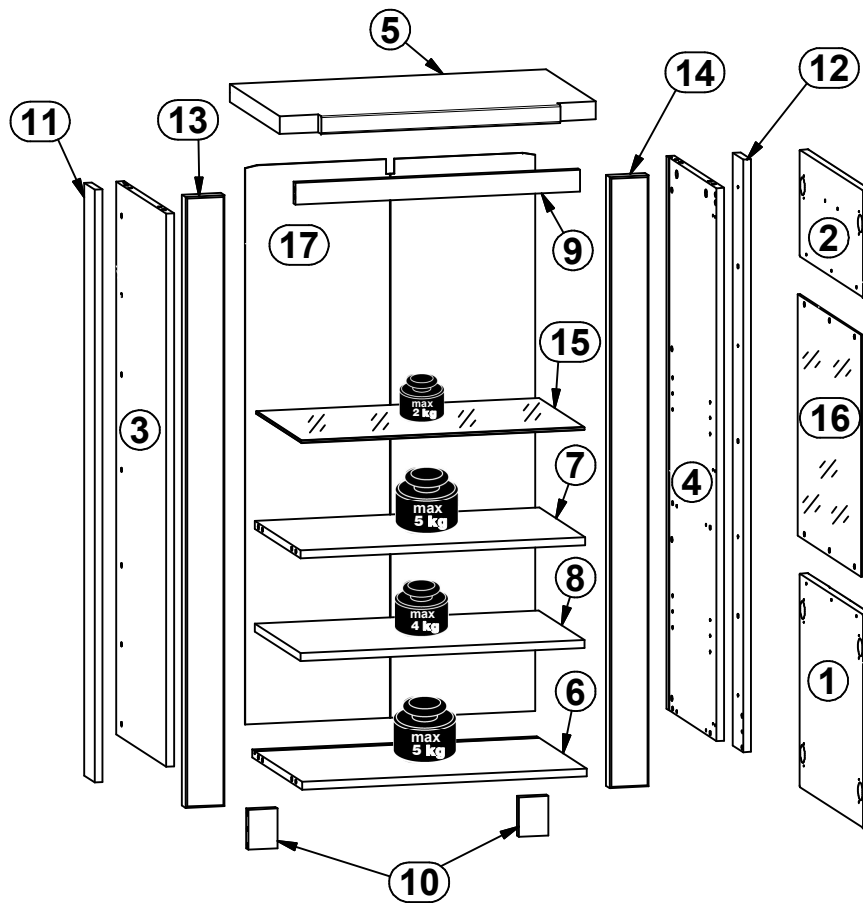

A	B	C (mm)		D
1	S378-0003	430	486	2/3
2	S378-0004	215	486	2/3
3	S378-1003	1114	382	1/3
4	S378-1004	1114	382	1/3
5	S378-2001	649	405	2/3
6	S378-3001	584	382	2/3
7	S378-3002	584	350	1/3
8	S378-3003	583	350	1/3
9	S378-4001	584	44	2/3
10	S378-5005	80	60	3/3
11	S378-5006	1194	80	3/3
12	S378-5007	1194	80	3/3
13	S378-5008	1231	80	3/3
14	S378-5009	1231	80	3/3
15	S378-5051	582	345	2/3
16	S378-5053	487	485	2/3
17	S378-9302	1126	595	1/3

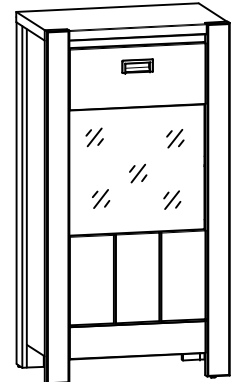
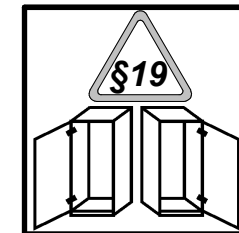

3x a132	1x a133	3x b43	1x c468 96 mm	4x d1 Ø5x17 mm	4x d3 Ø5x17 mm	6x d37	6x e2 Ø6.3x13 mm	8x e22 Ø7x28 mm	6x e47 Ø5x16 mm	20x f1 Ø8x30 mm	6x f13 Ø8x20 mm	1x f35 Ø10x50 mm
6x k1	14x l2	1x n1412 86x21x15/1.5	6x o54 Ø5.3/Ø8.3x4.8 mm	1x o601 2x1.8W	1x o602	1x o6013	1x o8314 10x18 mm	2x p123 Ø2x8 mm	1x p17 Ø5x60 mm	32x p38 Ø3.5x16 mm	6x p51 Ø3.5x15 mm	2x p59 Ø4x12 mm
14x r1 Ø15x12 mm #16	14x r42 20/11	8x s1	4x s2 Ø16	3x s71 Ø35x62x40x10	1x z1 4 mm							



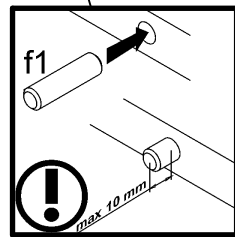
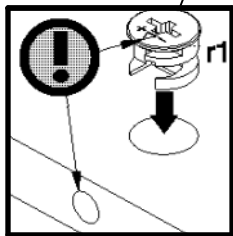
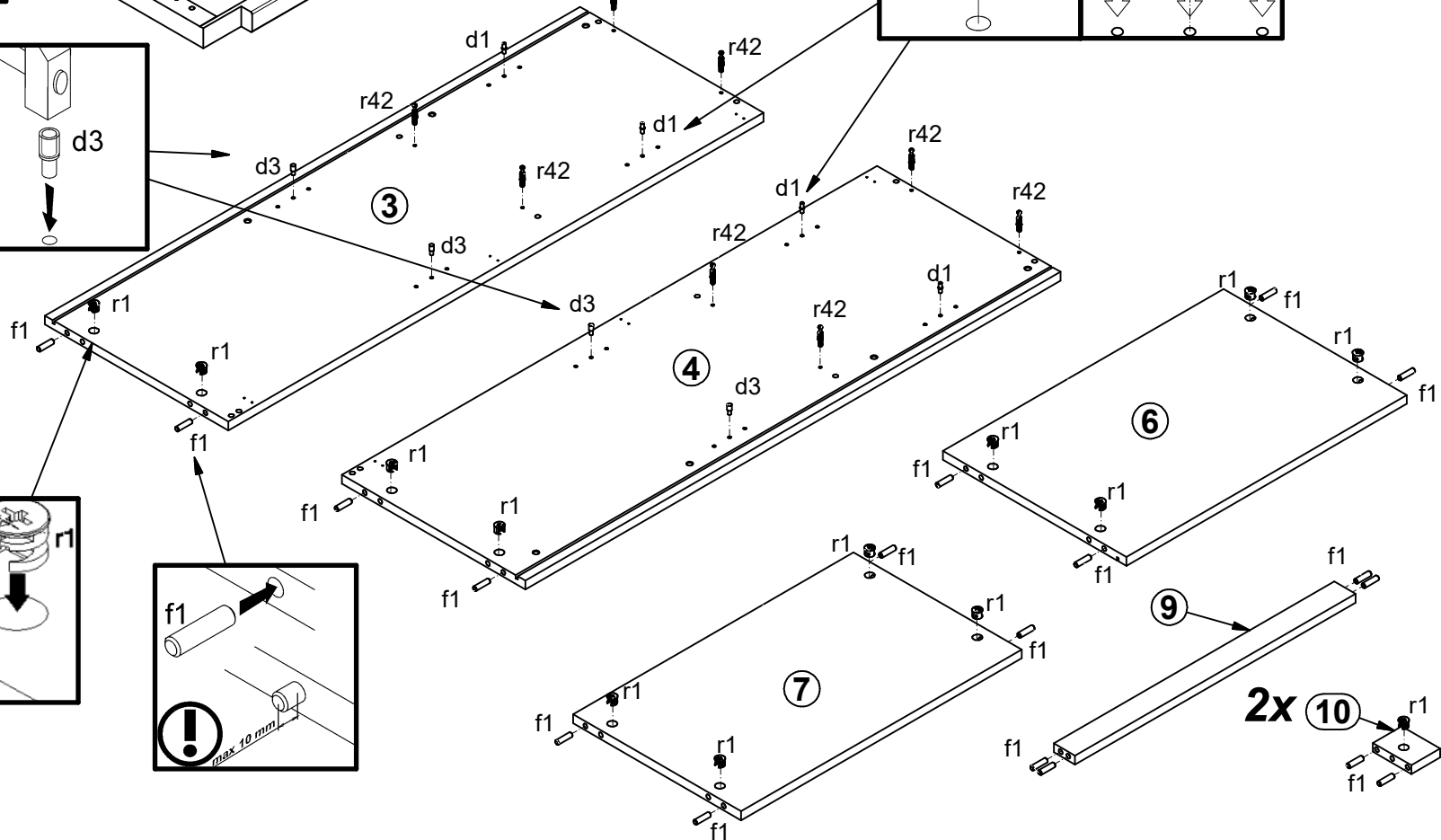
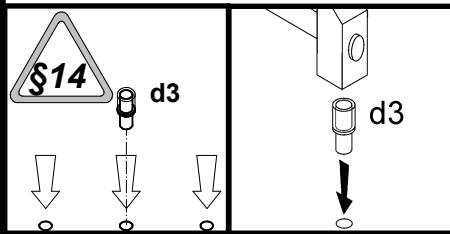
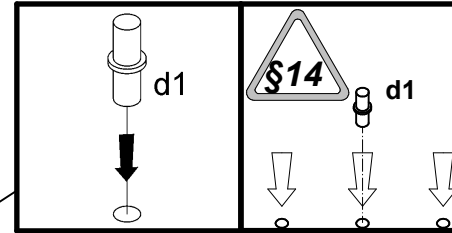
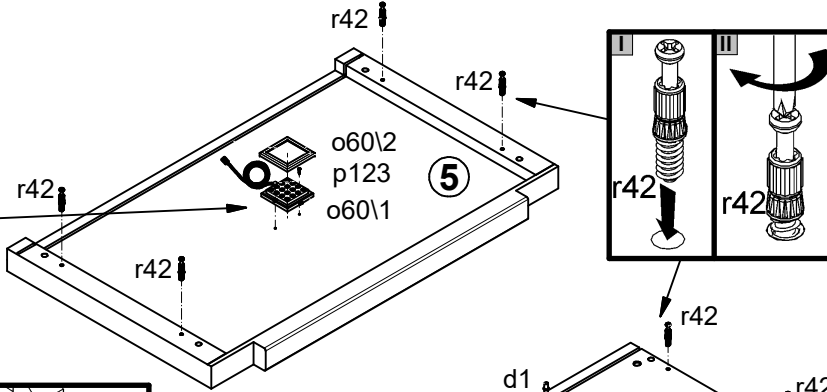
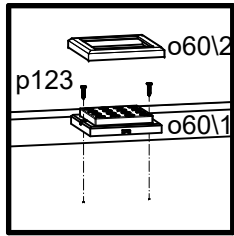

1

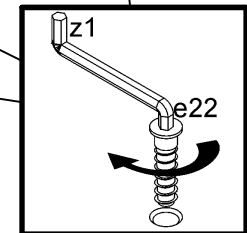
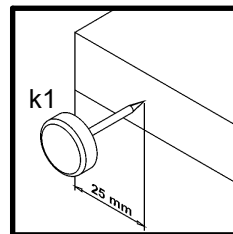
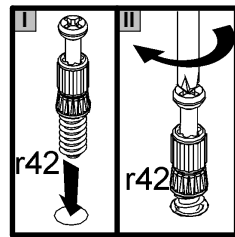
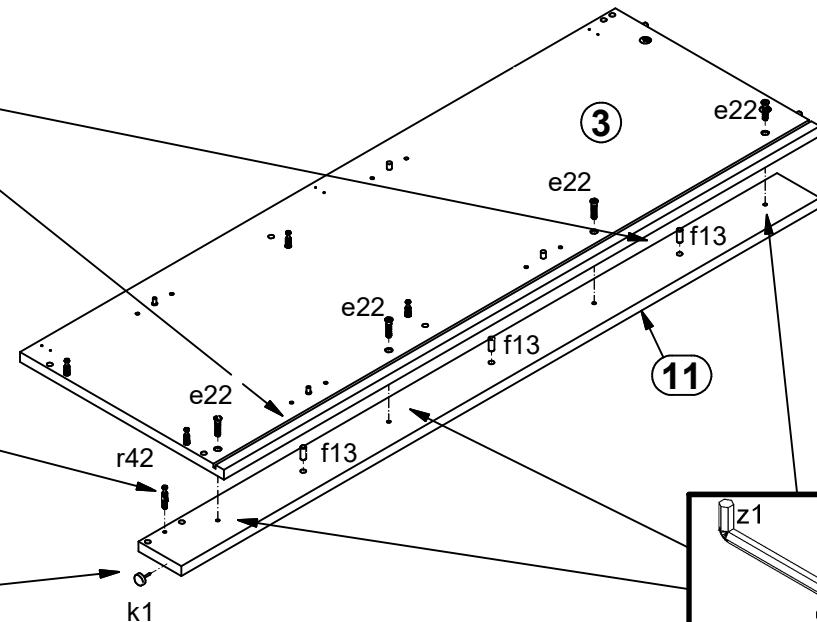
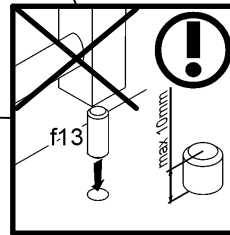
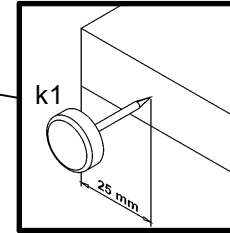
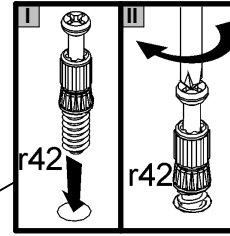
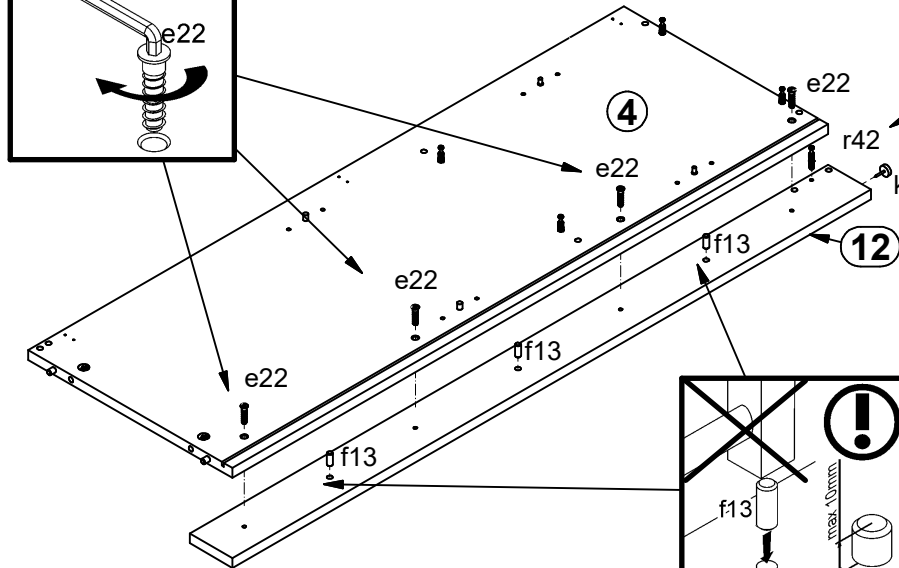
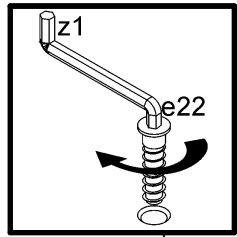

- 4x $\varnothing 5 \times 17$ mm d1
- 4x $\varnothing 5 \times 17$ mm d3
- 20x $\varnothing 8 \times 30$ mm f1
- 1x 2x1.8W o60\1
- 1x o60\2
- 2x $\varnothing 2 \times 8$ mm p123
- 14 $\varnothing 15 \times 12$ mm #16 r1
- 12x 20\11 r42

2 



- 8x  e22
Ø7x28 mm
- 6x  f13
Ø8x20 mm
- 2x  k1
- 2x  r42
20/11
- 1x  z1
4 mm

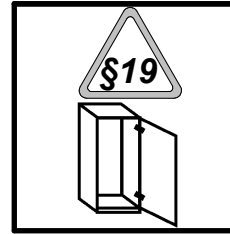
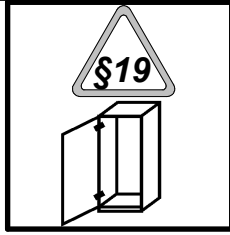

3x	b43	6x	d37	6x	e2 Ø6,3x13 mm
2x	k1	12x	p38		
					Ø3,5x16 mm

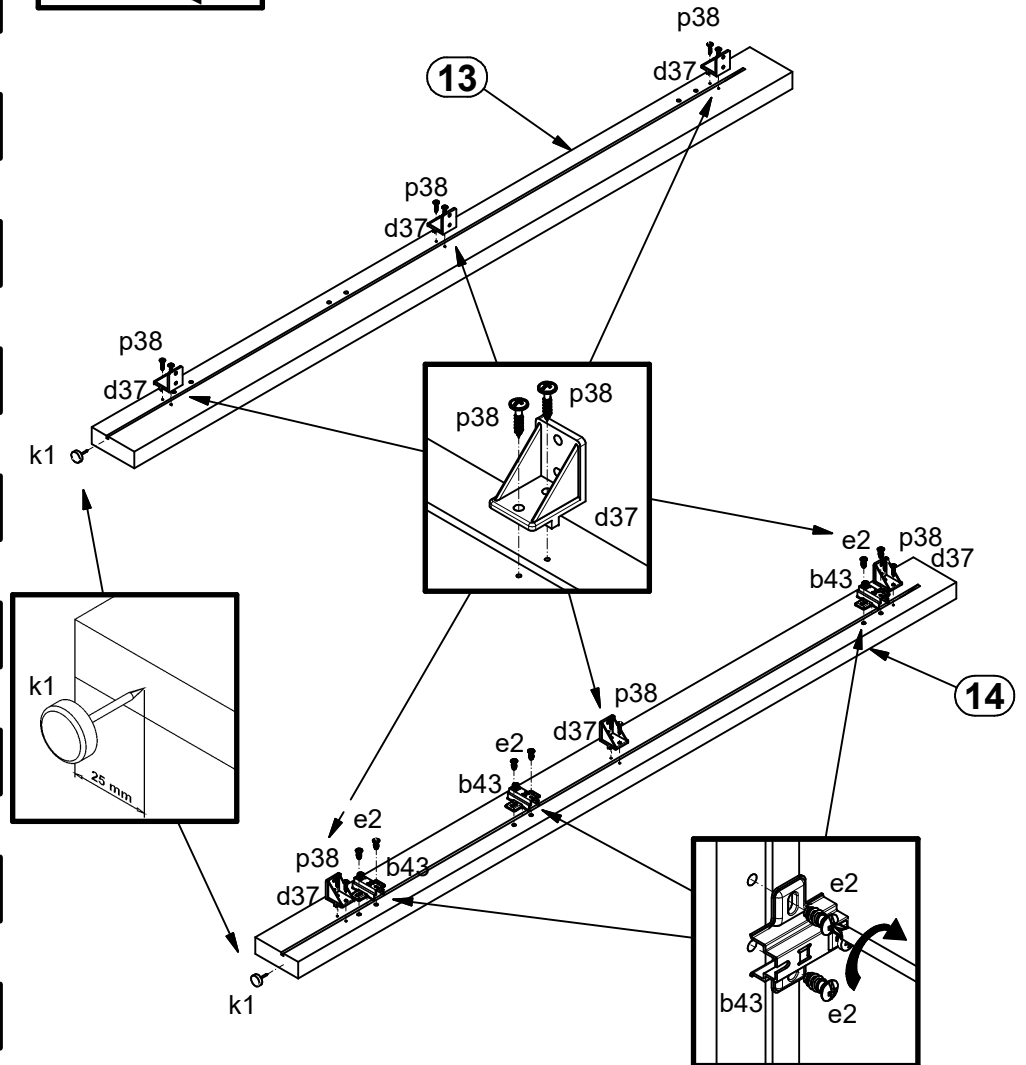
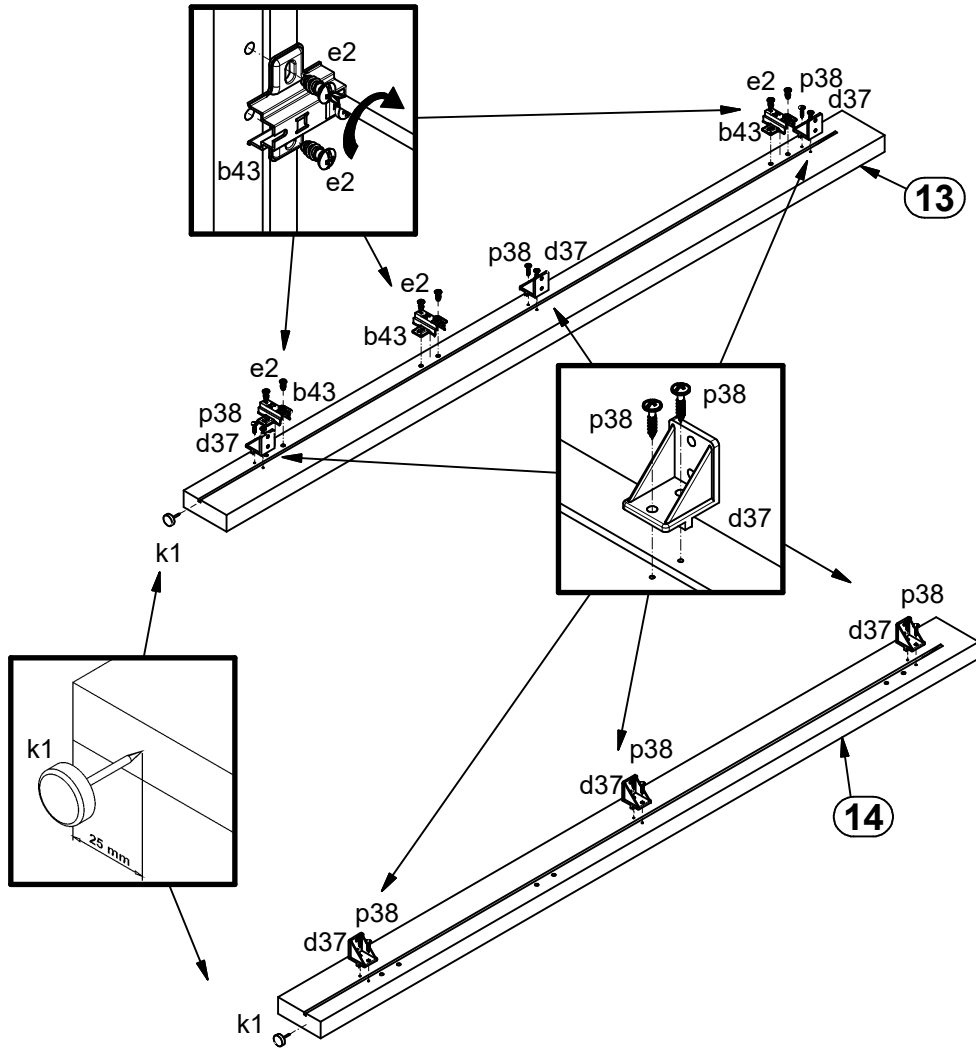

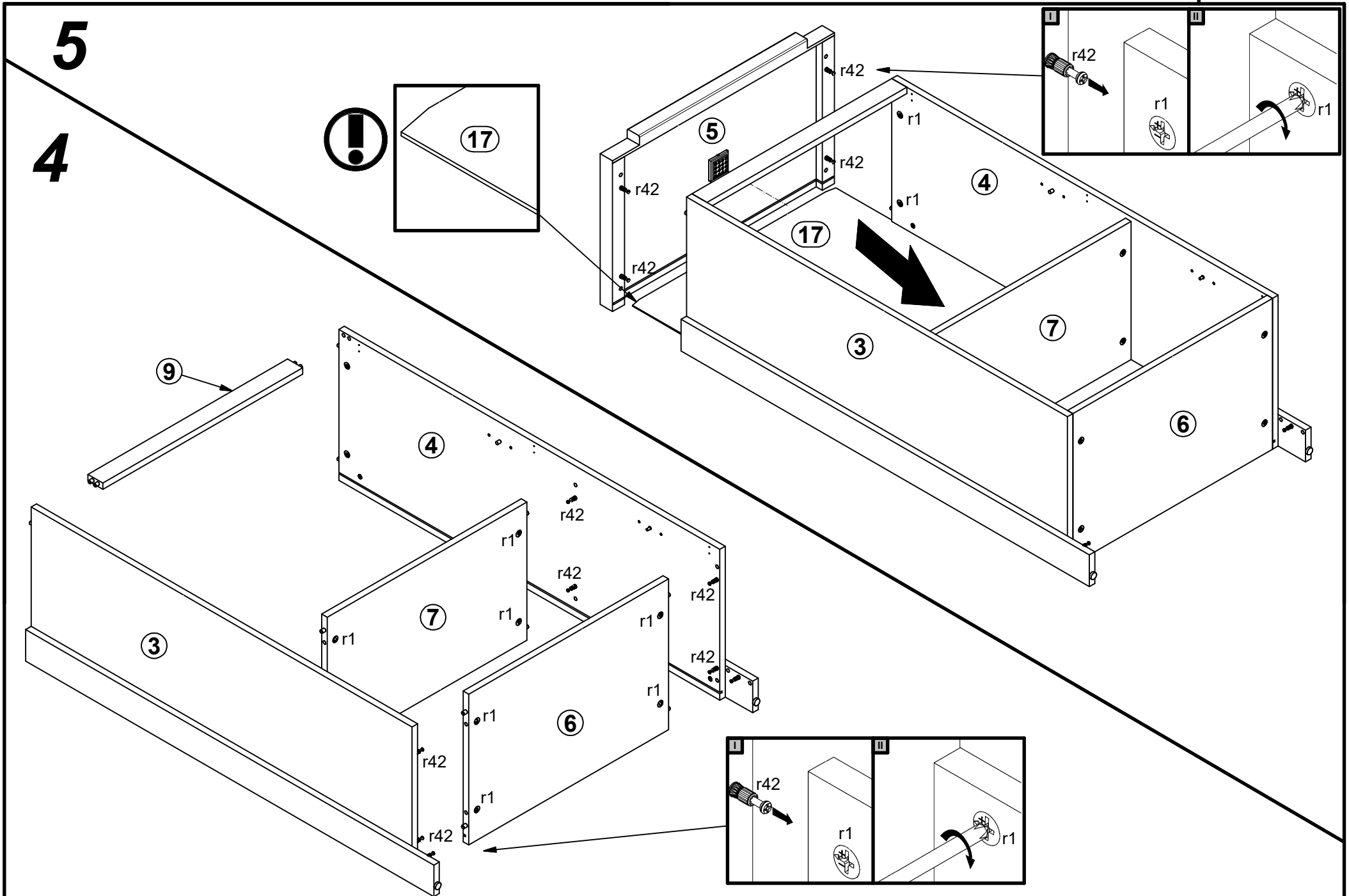

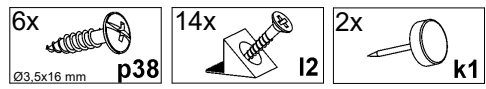

6

7

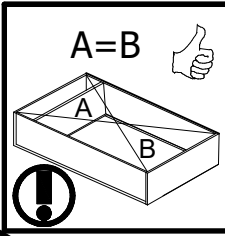

13

14

5

4

12

17

10

11





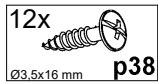
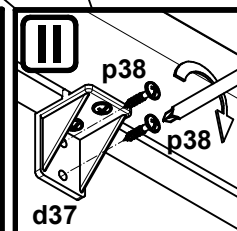
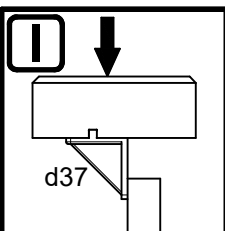
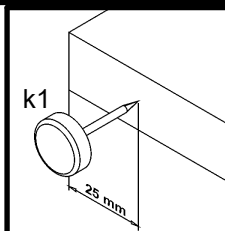
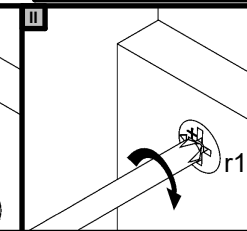
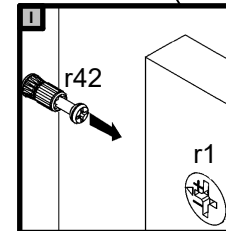
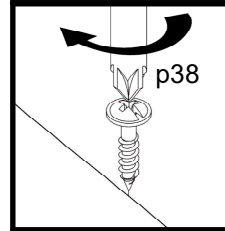
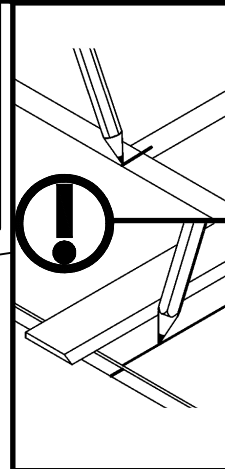
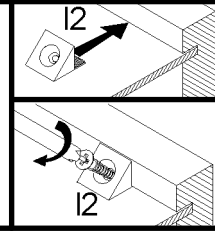
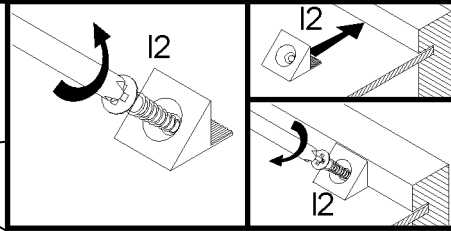

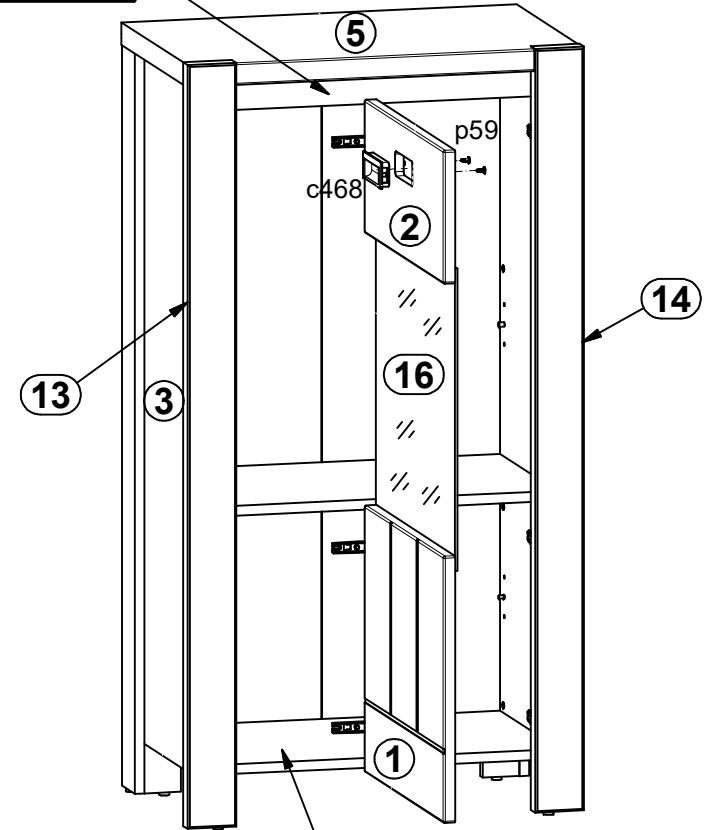
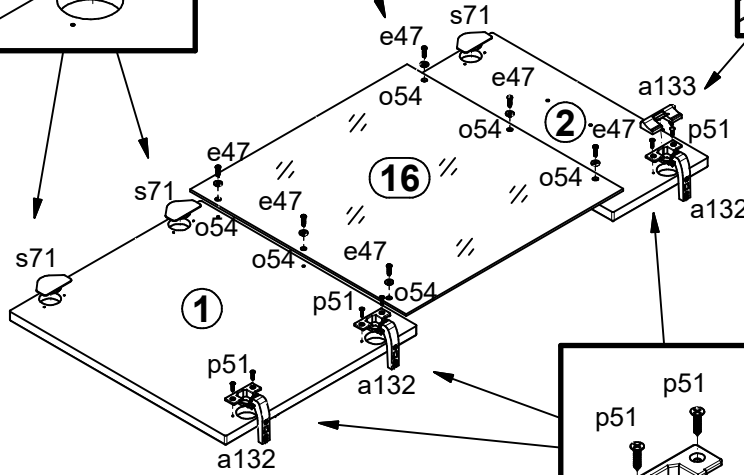
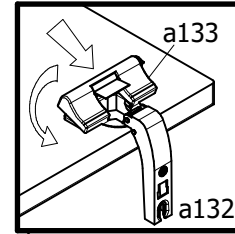
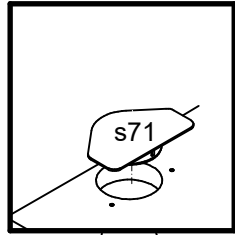
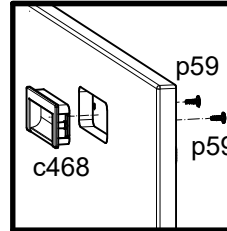
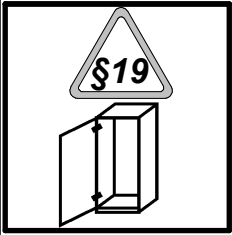

3

4

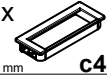

8  §11



3x  a132	1x  a133	1x  c468
6x  Ø5x16 mm e47	6x  Ø5,3/Ø6,3x4,8 mm o54	6x  Ø3,5x15 mm p51
2x  Ø4x12 mm p59	3x  Ø35x62x40x10 s71	

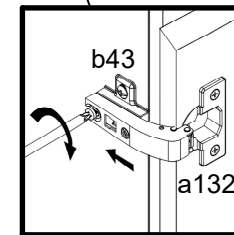
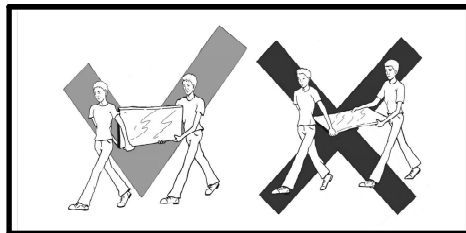

9

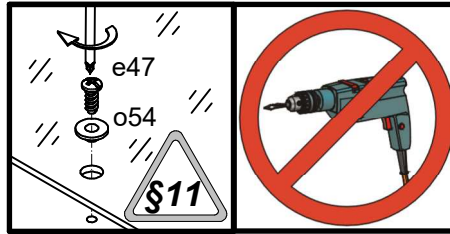
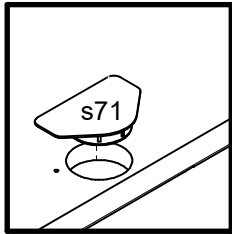
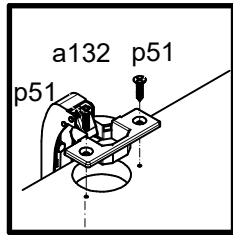
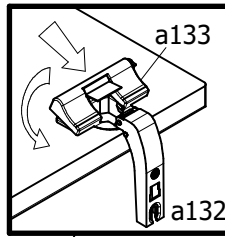
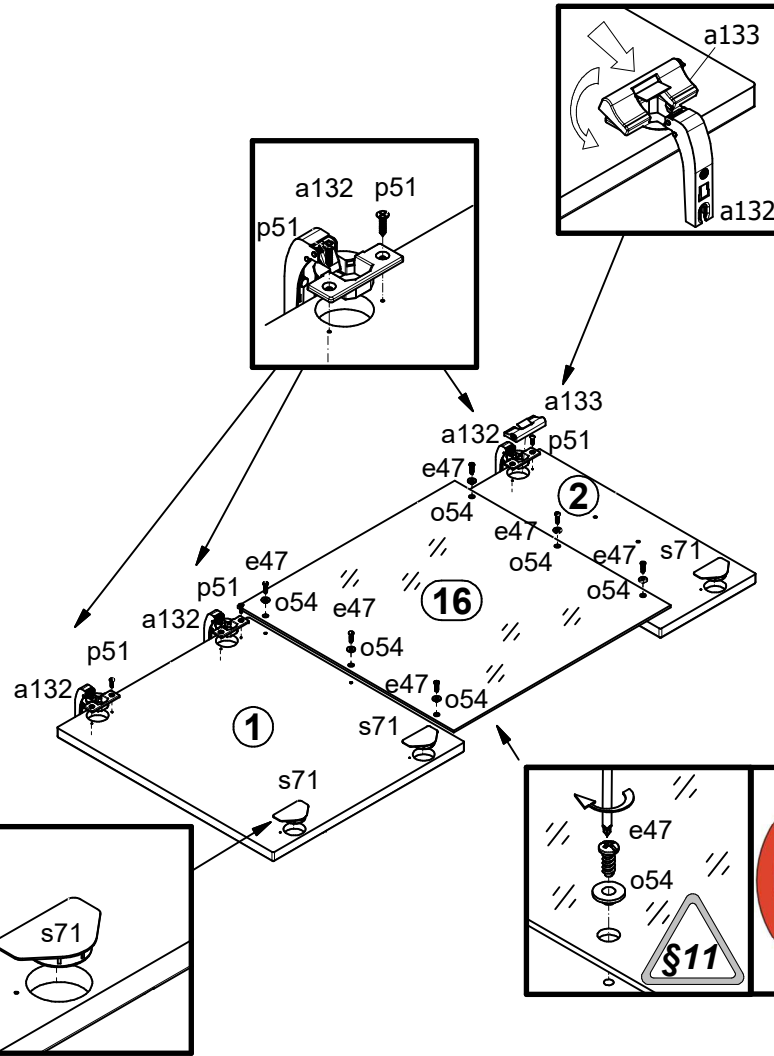
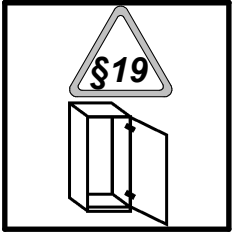

13

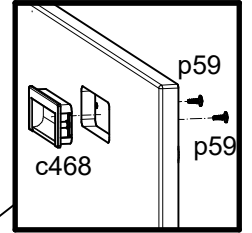
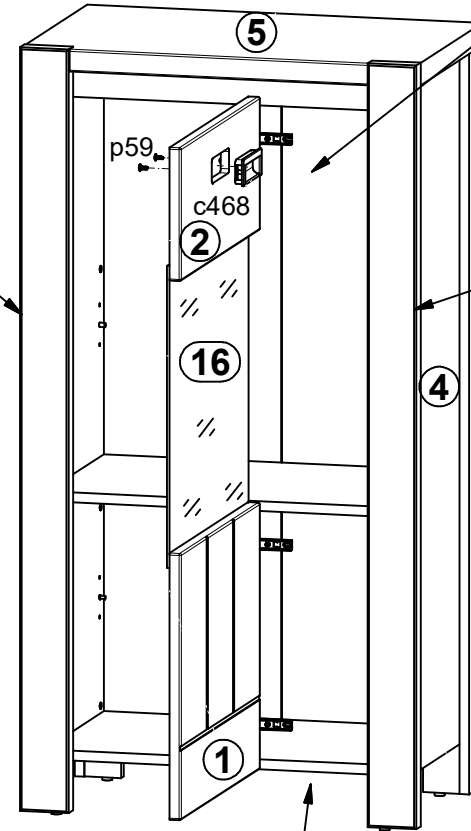

14

3x a132	1x a133	1x c468
6x e47 Ø5x16 mm	6x o54 Ø5.3xØ8.3x4.8 mm	6x p51 Ø3.5x15 mm
2x p59 Ø4x12 mm	3x s71 Ø35x62x40x10	

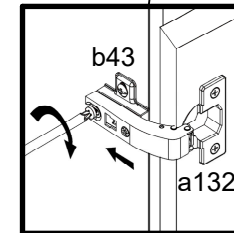
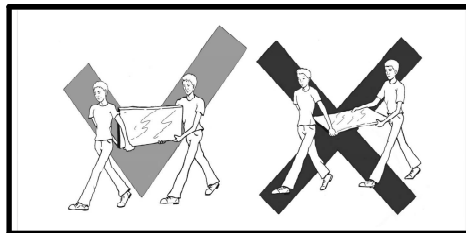

10

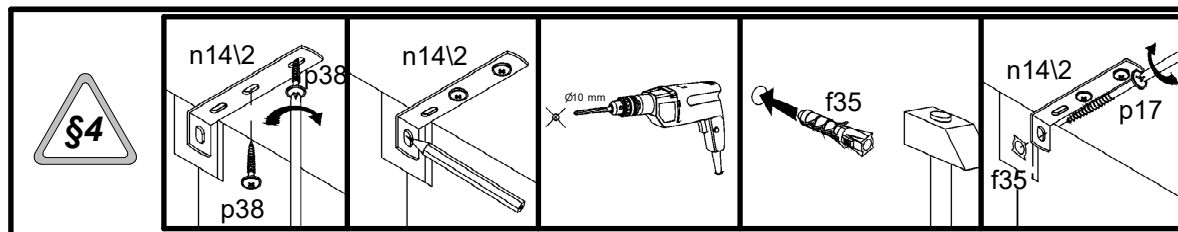
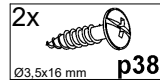
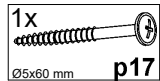
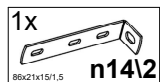
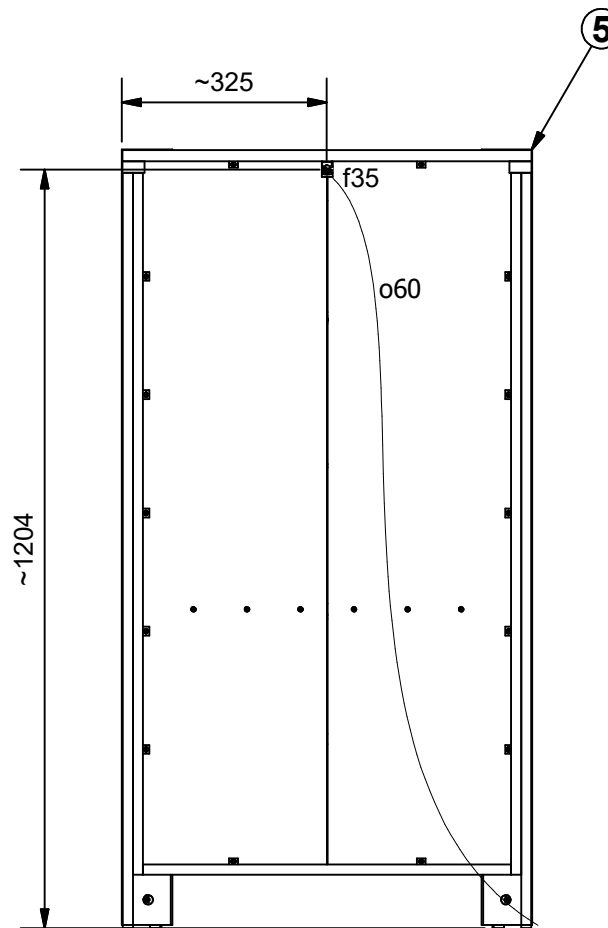
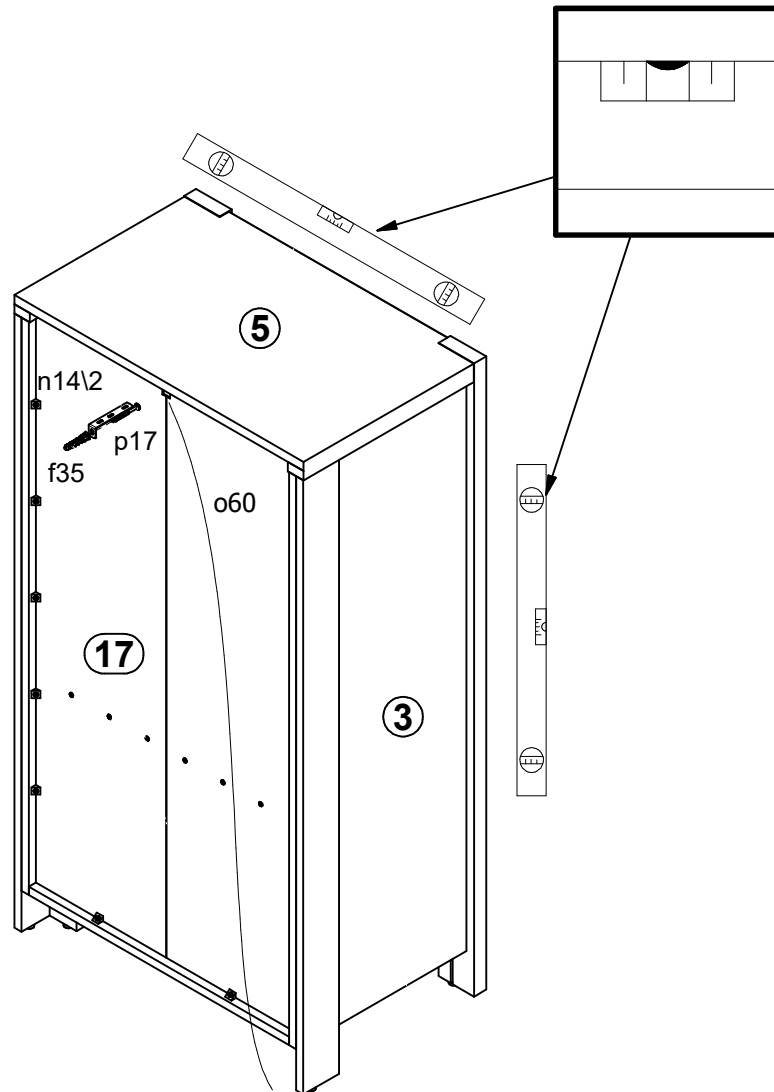
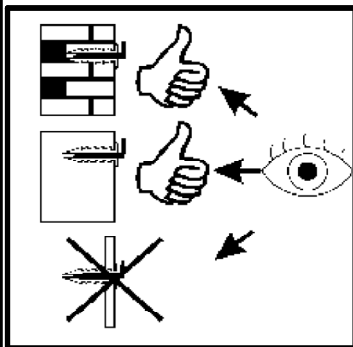

11

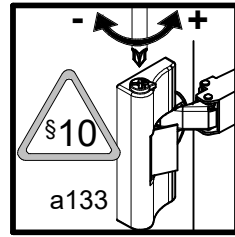

1x		1x	
	o60\3	10x18 mm	o83\4
8x		4x	
	s1	Ø16	s2

