

A	B	C		D	A	B	C		D
1	S322-150	2000	200	1/2	5	ZZ1-412	203	70	1/2
2	S322-151	2000	200	1/2	6	ZZ1-423	267	70	1/2
3	S322-427	1650	840	2/2	7	ZZ1-719	1983	70	1/2
4	S322-428	1650	440	2/2	8	ZZ1-747	1880	25	1/2

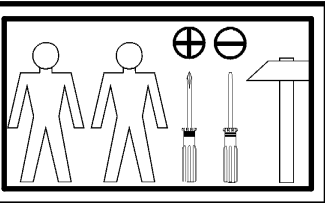

**A**

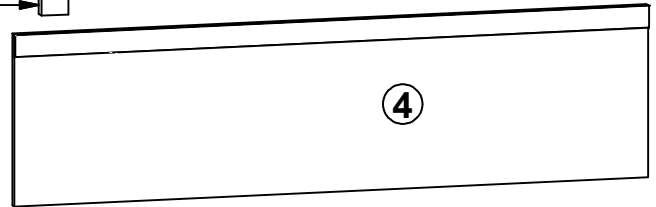
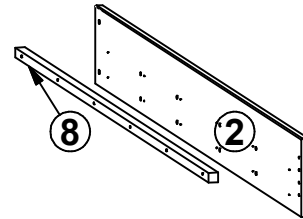
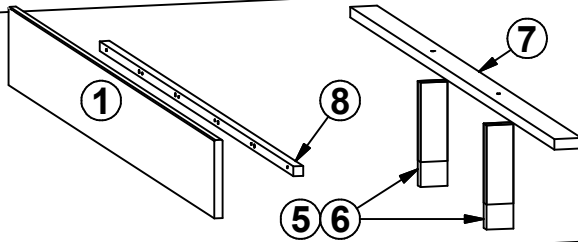
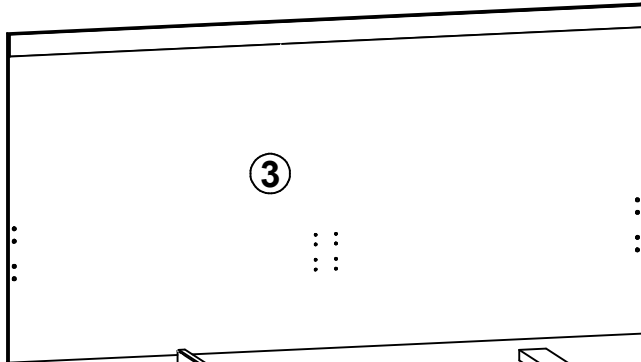
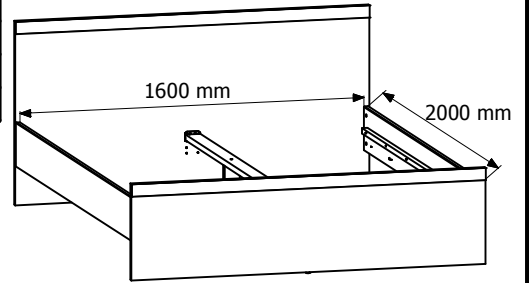
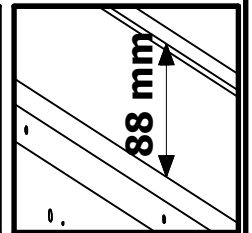
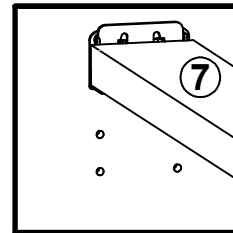
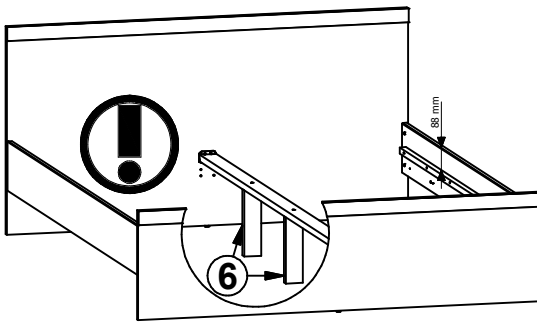

**B**

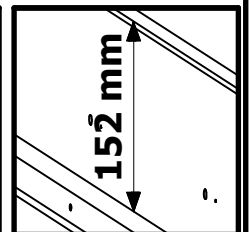
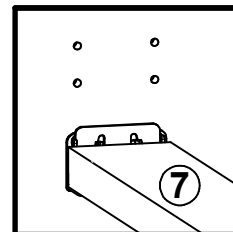
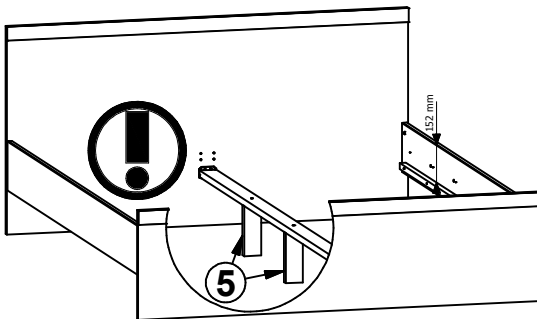

16x Ø6.3x13 mm e2	8x Ø6x13 mm e3	2x Ø7x60 mm e8	12x Ø8x30 mm f1	4x M6x65 mm j132	6x k1	2x n3411	2x n3412	2x 130x34x34/2 mm n63
12x Ø4x40 mm p10	6x Ø3.5x25 mm p16	6x Ø4x35 mm p6	4x Ø10x16 mm r43	1x z1				

1  

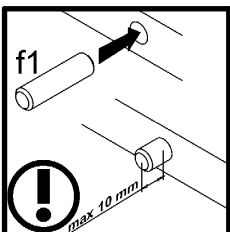
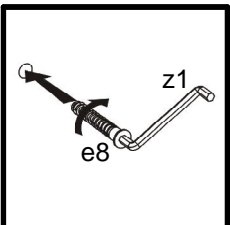
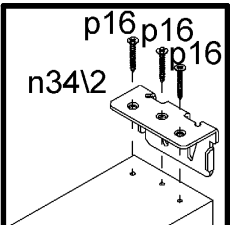
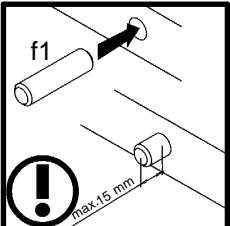
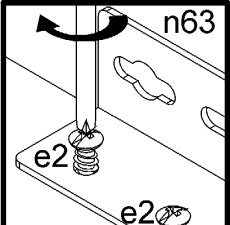
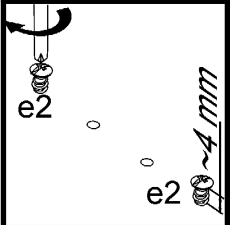
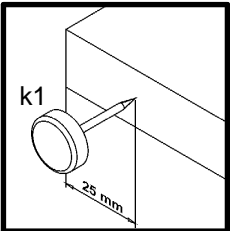
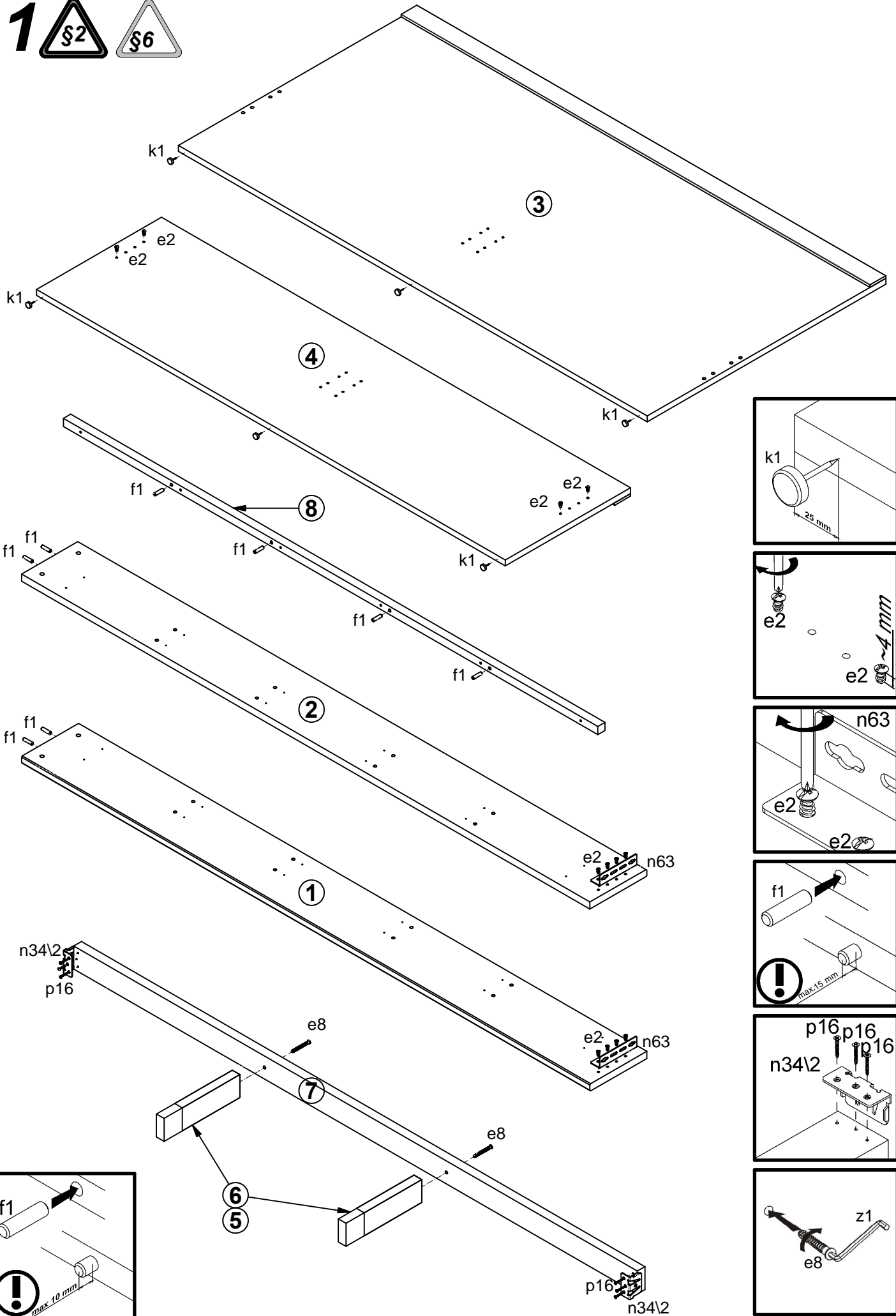

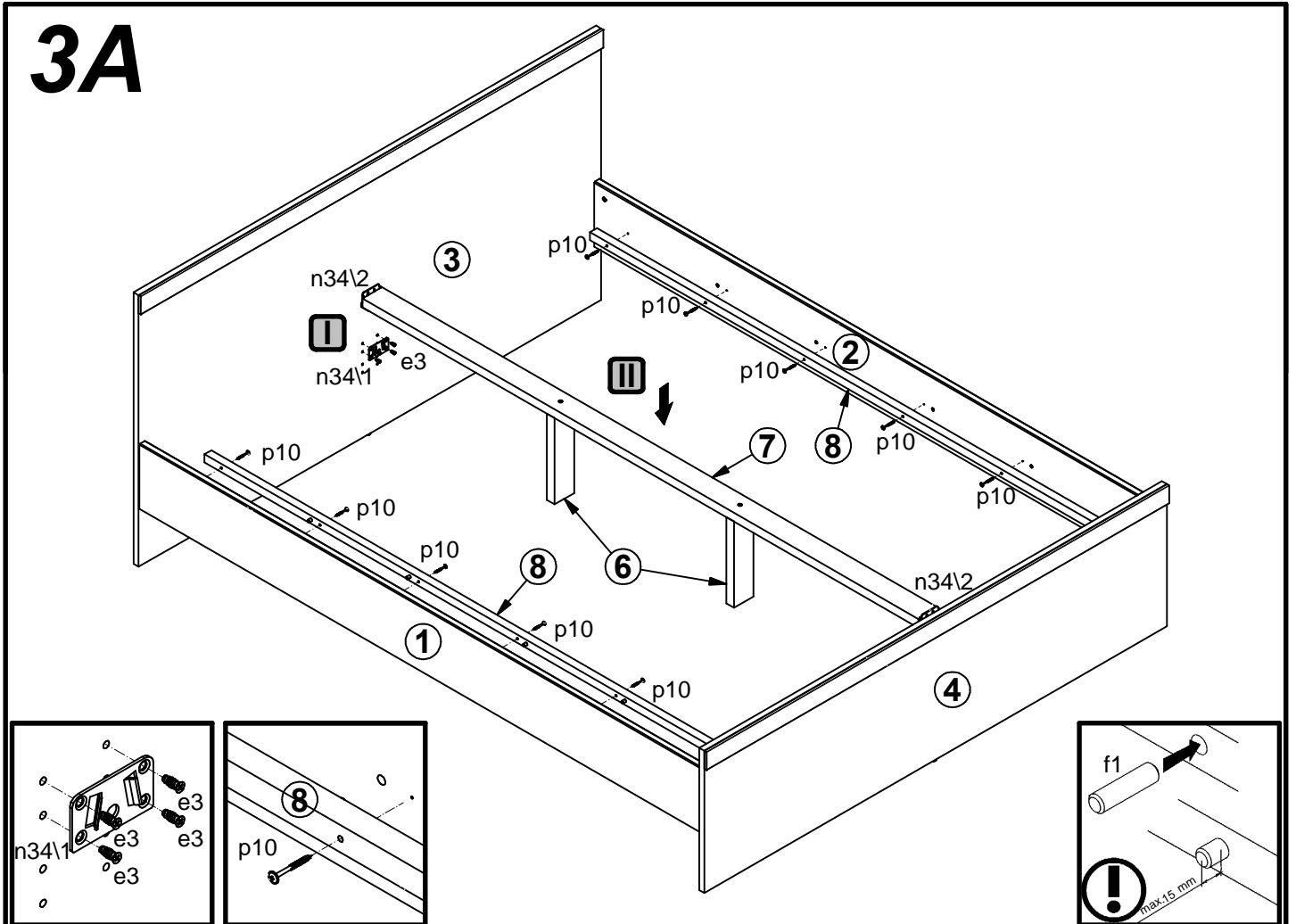
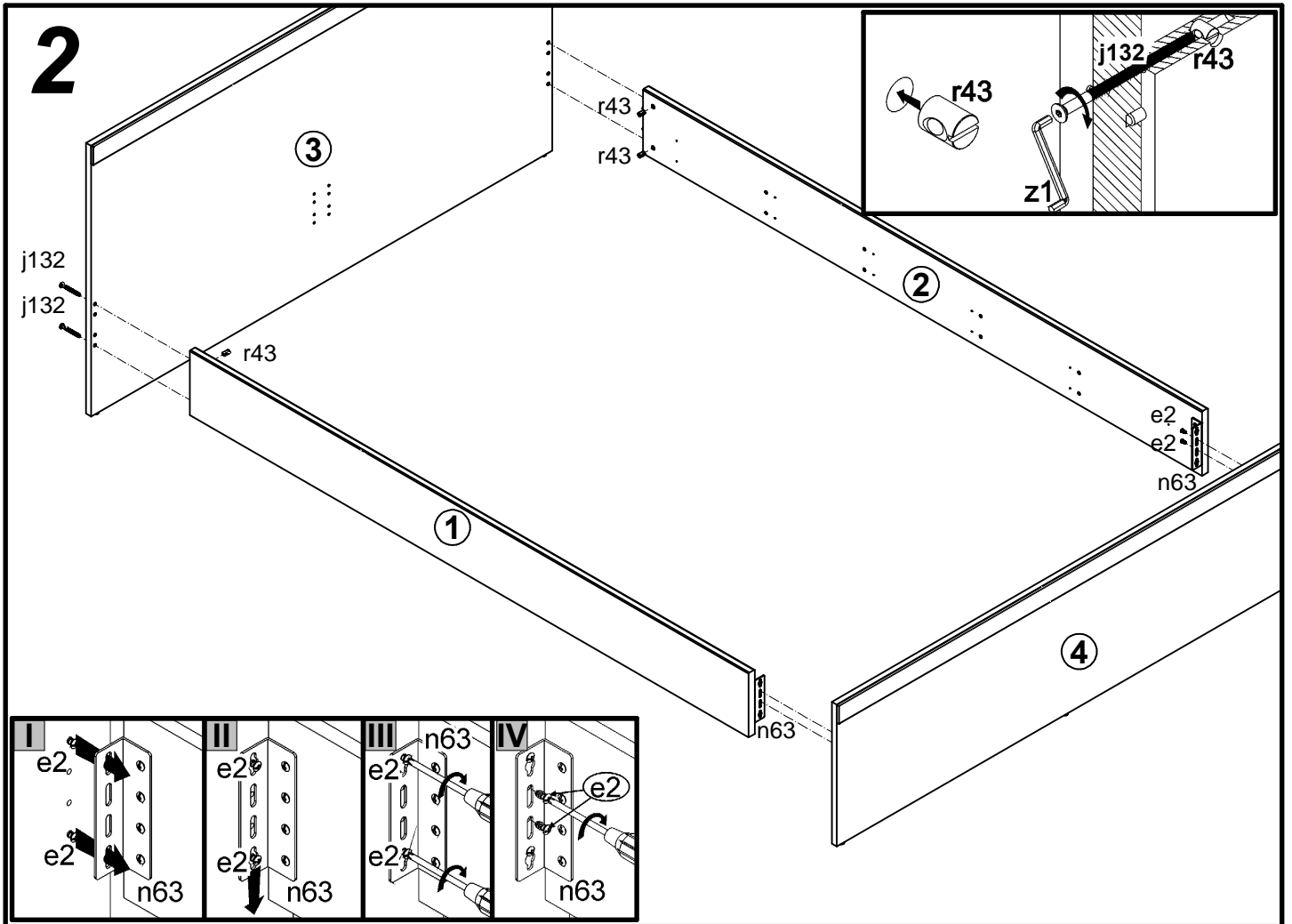

# 3B

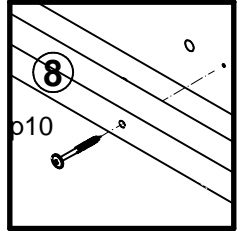
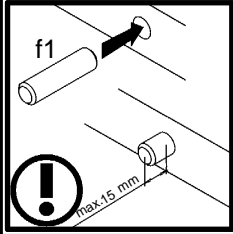
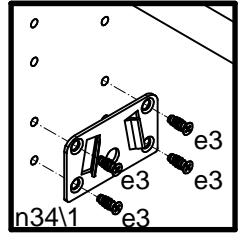
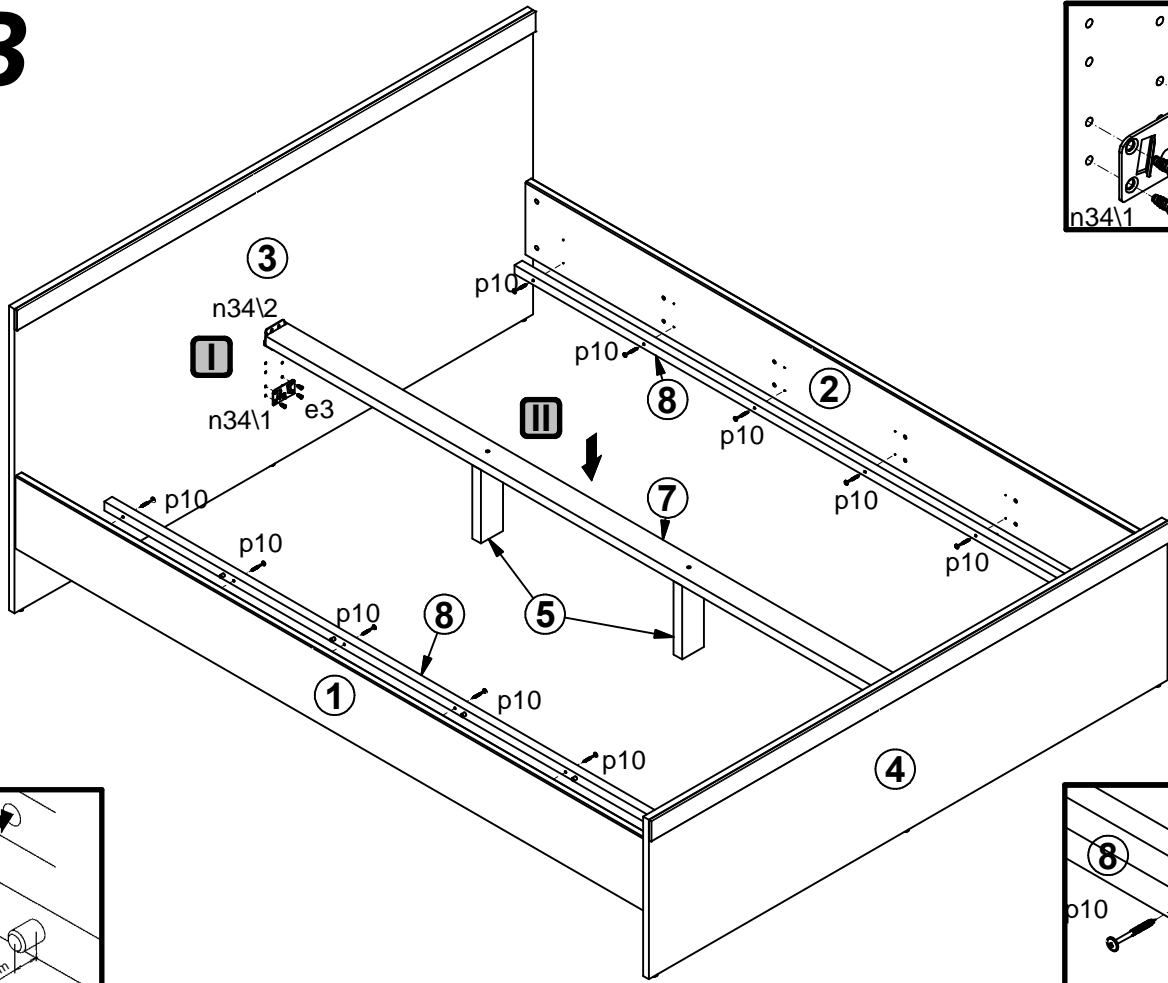

# 4

