

A

NAMEK

S412-REG3D

| A | B | C | D |
|----|-----------|-------|------|
| 1 | S412-0008 | 584 | 446 |
| 2 | S412-0010 | 1452, | 446, |
| 3 | S412-0011 | 584, | 446, |
| 4 | S412-1011 | 1956, | 377 |
| 5 | S412-1012 | 1956, | 377 |
| 6 | S412-1013 | 1892 | 355, |
| 7 | S412-2005 | 950 | 380 |
| 8 | S412-3012 | 901 | 374, |
| 9 | S412-3013 | 442,5 | 355, |
| 10 | S412-3014 | 442 | 348 |
| 11 | S412-4001 | 901 | 60 |
| 12 | S412-5701 | 920, | 50, |
| 13 | S412-5702 | 330, | 50, |
| 14 | S412-9004 | 1916, | 460 |

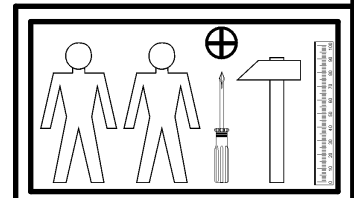
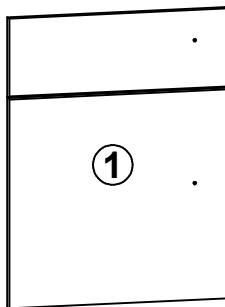
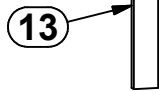
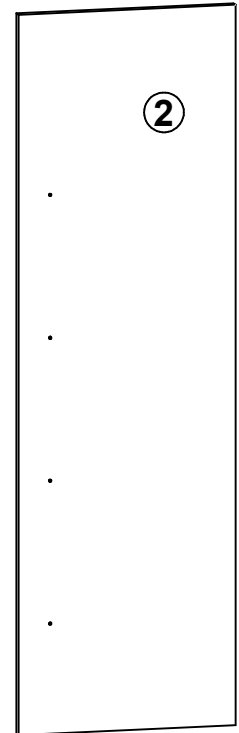
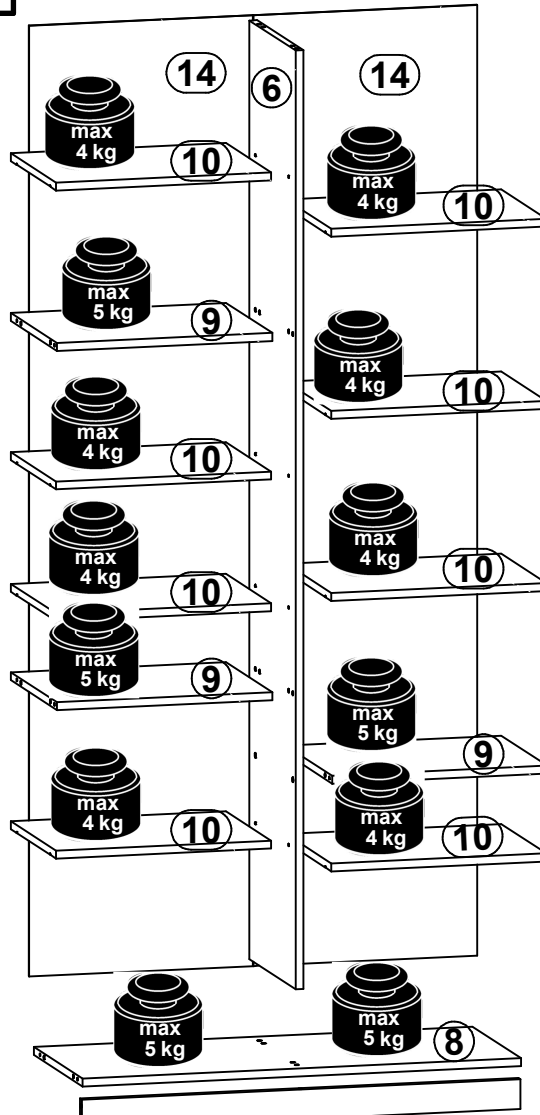
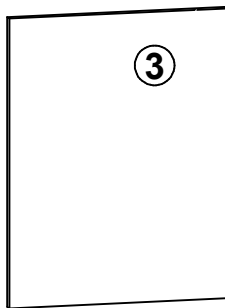
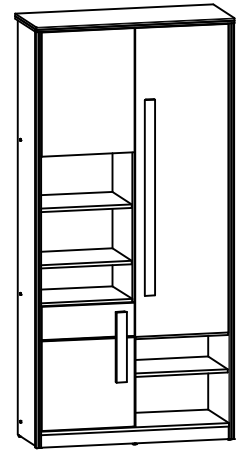

| | | | | | | | | |
|--------------------------|-----------------------|---------------------------|------------------------------|------------------------|-----------------------|-----------------|-------------------------|----------------------|
| 7x K16 a43 | 7x D5 b60 | 32x Ø5x17 mm d1 | 18x Ø7x50 mm e1 | 14x Ø5x12 mm e41 | 29x Ø8x30 mm f1 | 5x k1 | 100x 1.4x20 mm l1 | 6x silikon o21 |
| 14x Ø3.5x15 mm p51 | 6x Ø4x28 mm p94 | 2x Ø15x12 mm #16 r1 | 4x Ø12x10.5 mm #12 r15 | 6x 20/9 r16 | 16x s1 | 2x Ø16 s2 | 4x Ø12 s34 | 1x 4 mm z1 |
| 1x Ø3.5x16 mm p38 | 1x n26 | | | | | | | |

1 

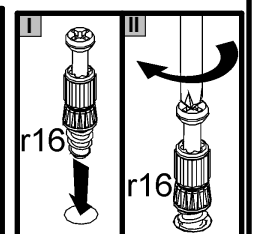
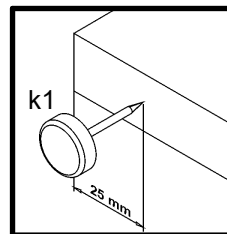
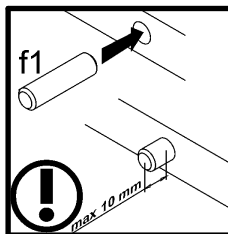
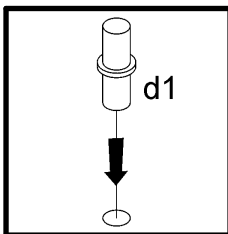
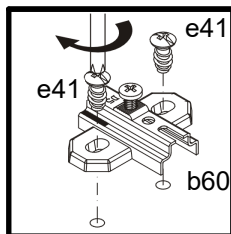
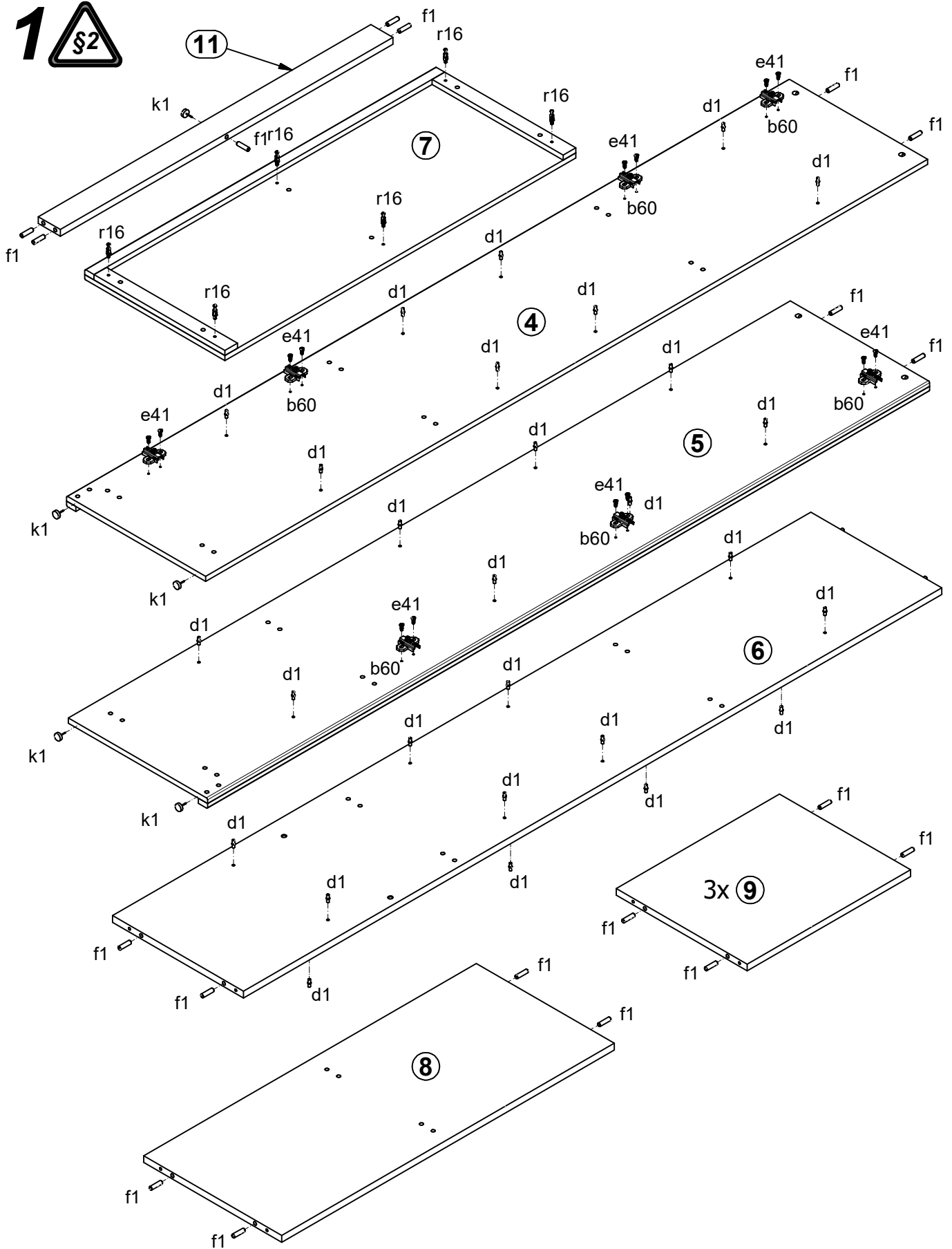

2

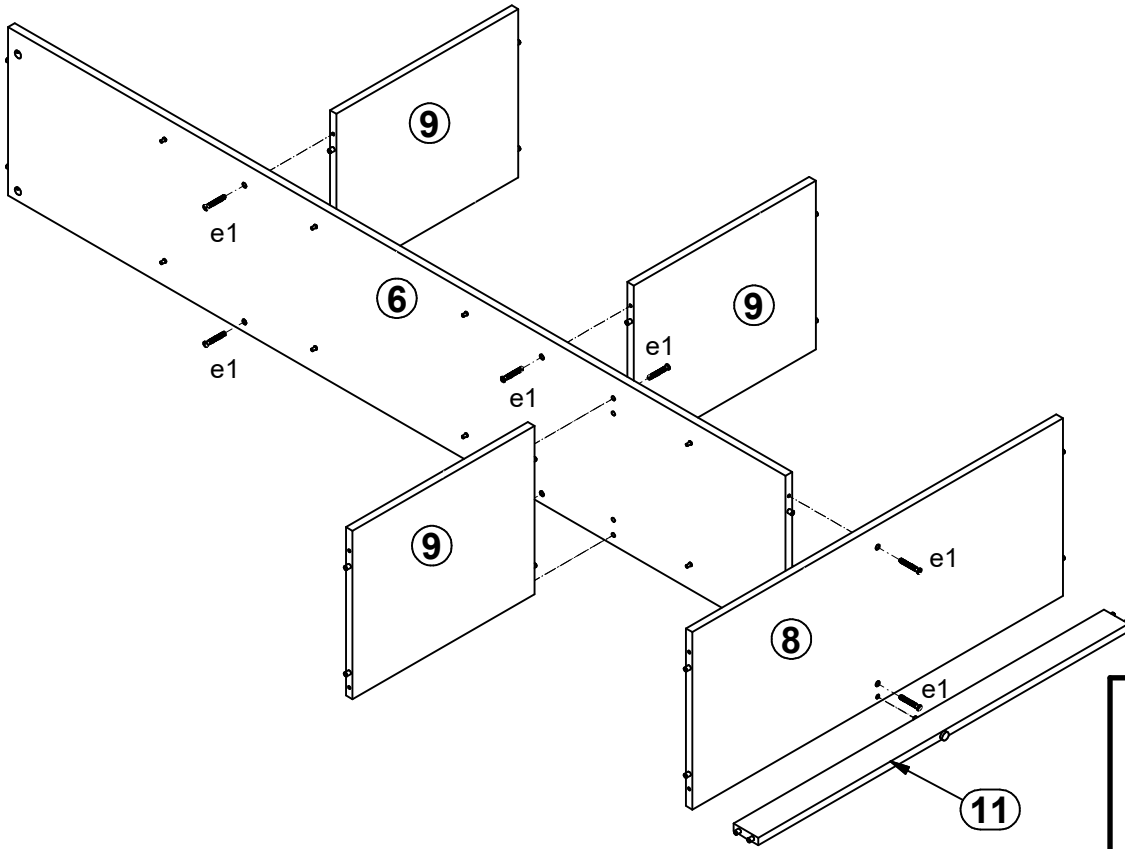

3

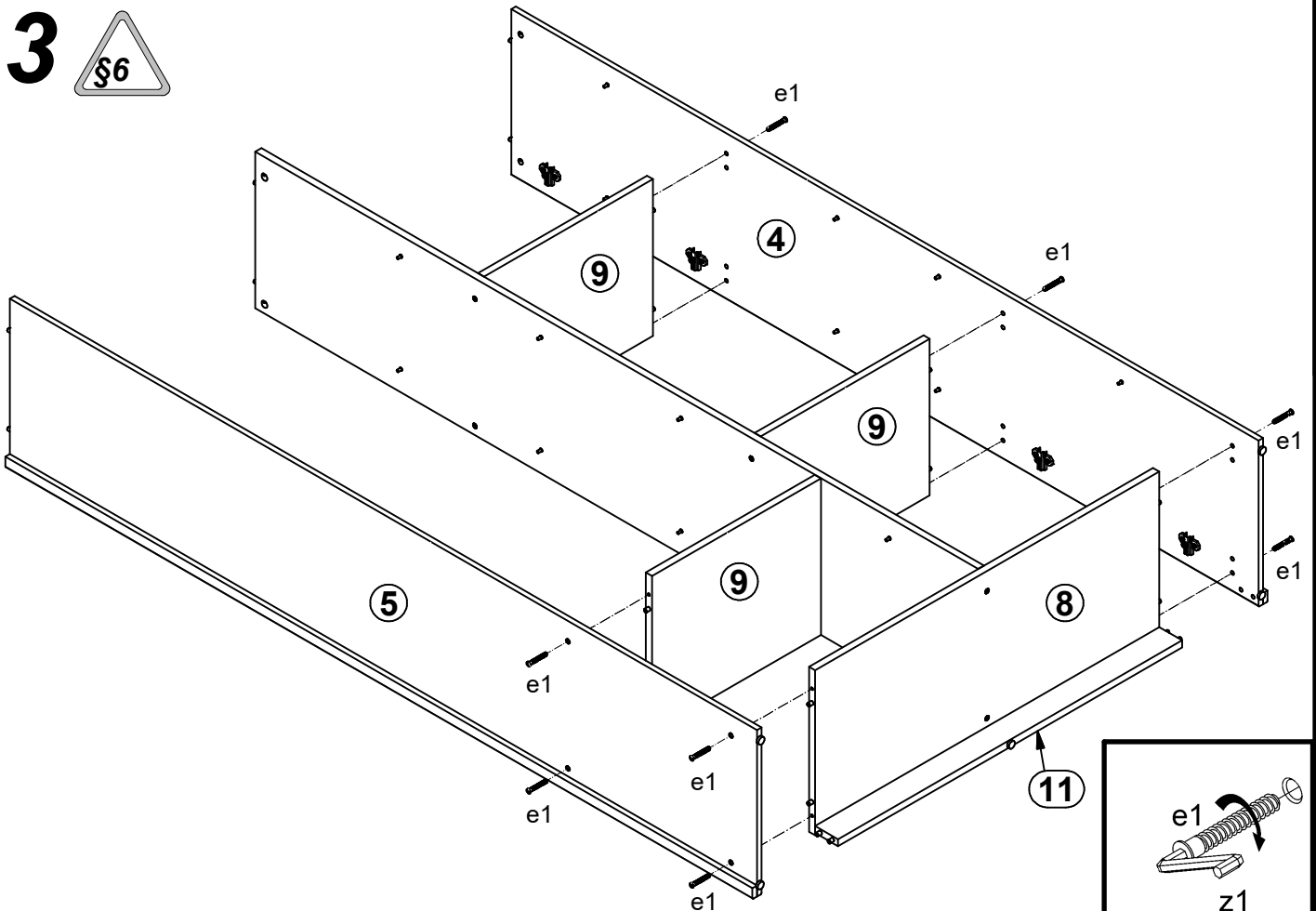

4

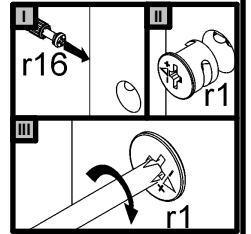
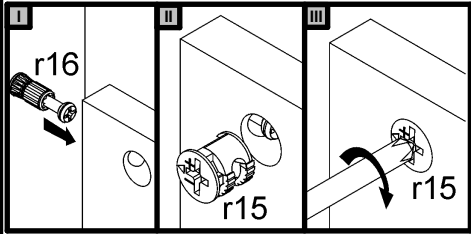
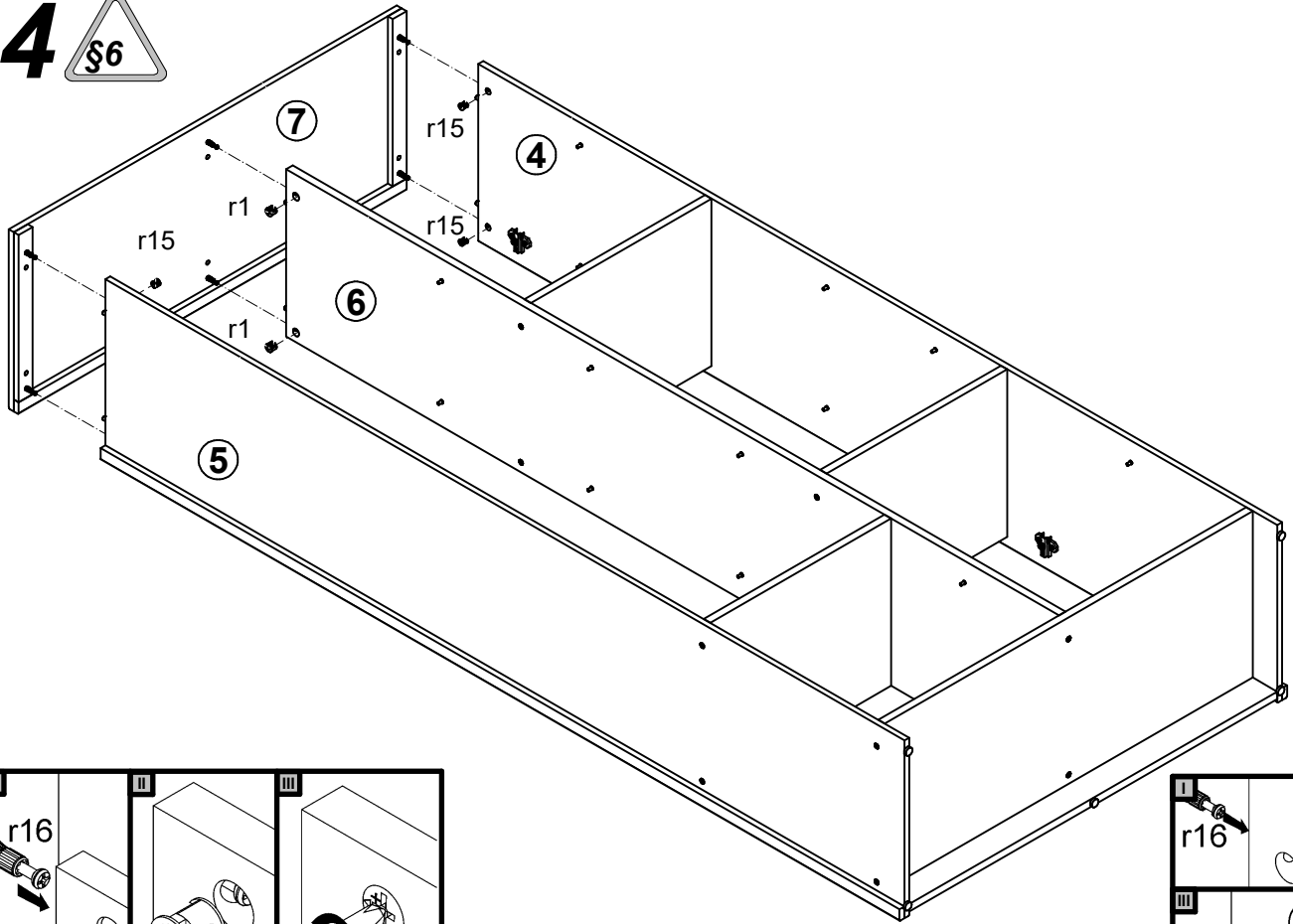

5

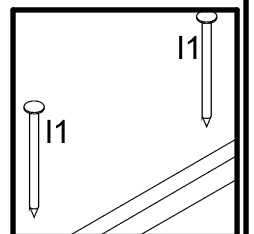
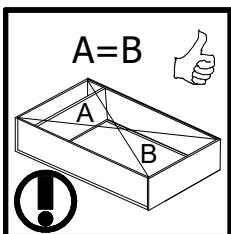
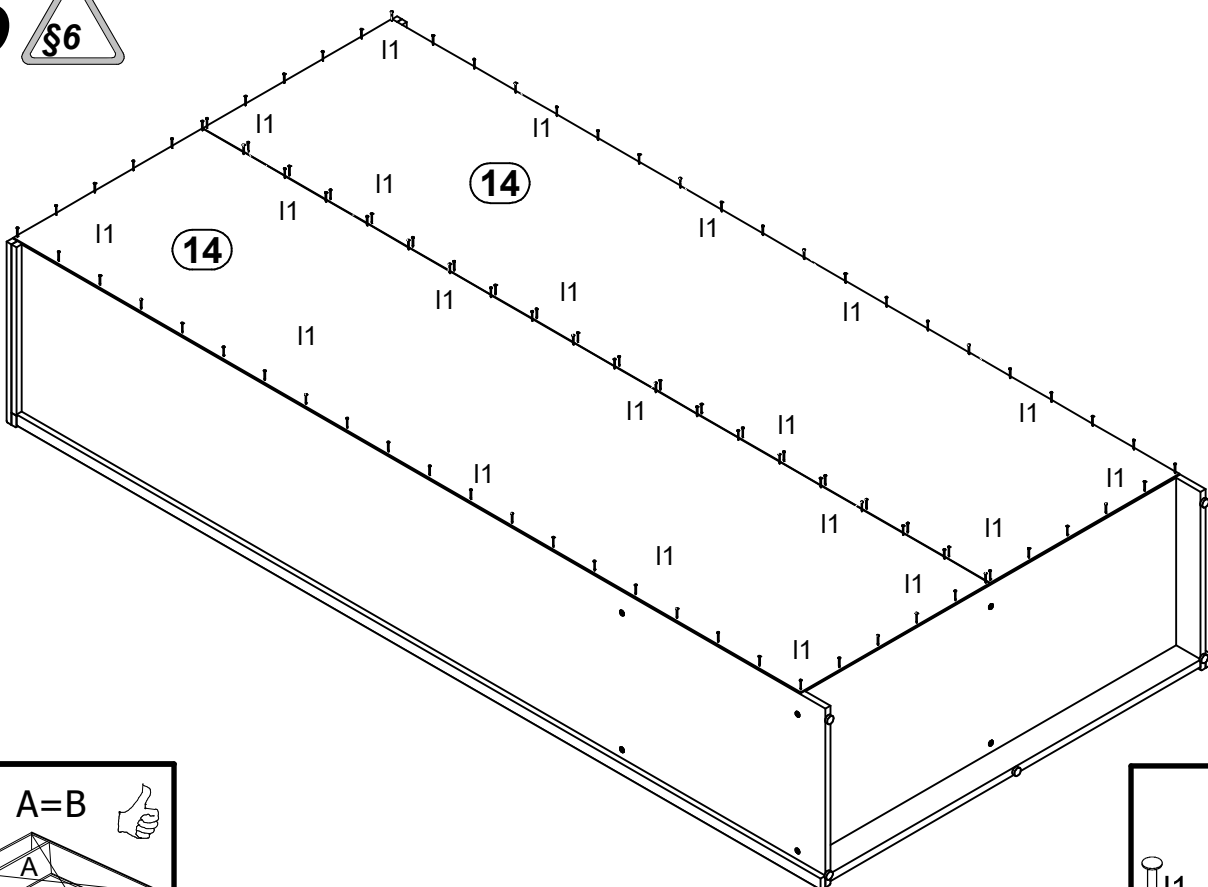

6

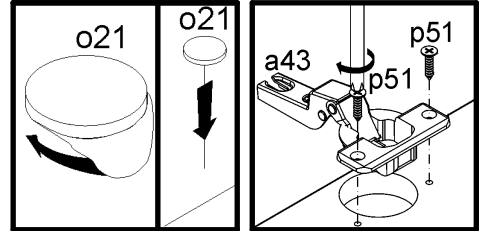
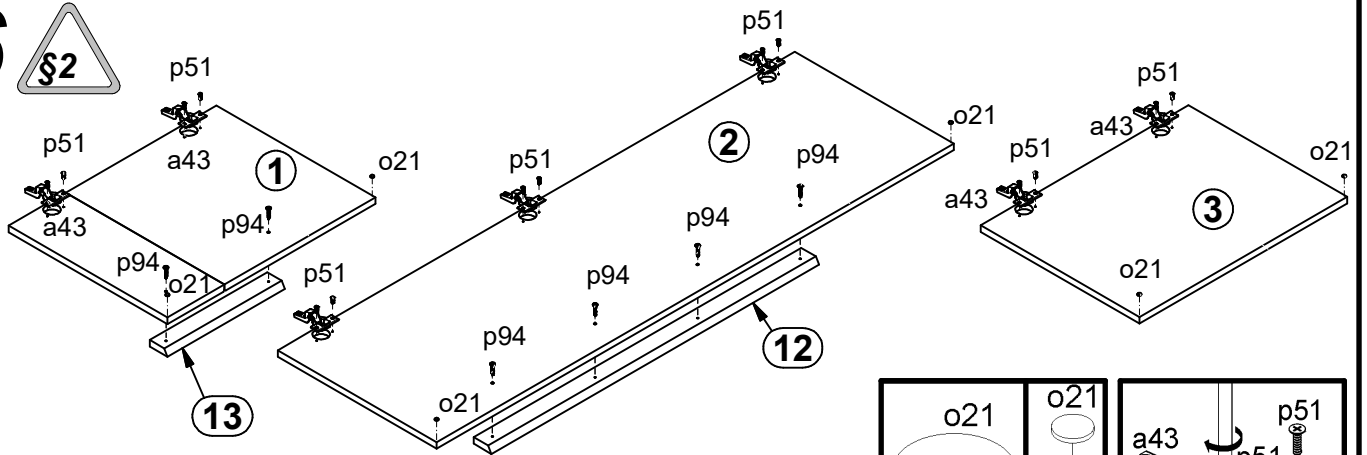

7

